



SitePro™

# TOOLS AND ACCESSORIES

FOR SURVEYING & CONSTRUCTION



Badlands National Park, USA

**David White®**

**GAMMON REEL®**

**SITEGEAR®**

**SALAMANDER  
SERIES®**



## 2023 NEW PRODUCTS



**STAKE WISKERS**

Page 51

*Look for the Salamander*



**FLAGGING ROLLS**

Page 51



**PERMANENT MARKERS**

Page 52



**RAIN COVER FOR TS**

Page 40



**8' PRISM POLE**

Page 18



**FIBERGLASS TRIPODS**

Page 28



**DRYWALLER SETS**

Page 43



**SURVEYOR POLE/PRISM KIT**

Page 18



**13-FT COMPACT LEVELING RODS**

Page 33

**RD 302 LASER DETECTOR**

Page 10



**TSC5 CRADLE SYSTEM**

Page 25



**32X DIGITAL AUTO LEVEL**

Page 11



**HYBRID SUSPENDERS**

Page 45

**POLE SHOE WITH POINT**

Page 24

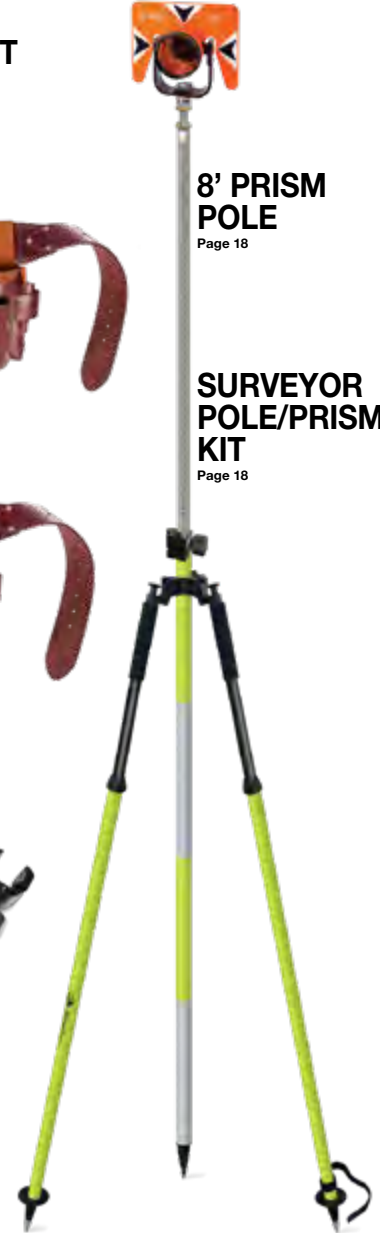

**BARCODE ROD FOR SDL32**

Page 33



**HYBRID FRAMER SETS**

Page 42



**XXL WORK BELTS**

Page 45





**Dave White's**  
**SitePro™**

**Dave White's SitePro** is a leading supplier of surveying and contractor's tools, accessories, optical and laser instruments, measuring devices, site gear, and field supplies for surveyors, industrial and construction use.

Since 2010, SitePro continues to give its customers the value and quality they seek to increase performance and best in class customer service. We're constantly looking for better solutions to improve the customer experience. Our customers deserve the best experience every time, and improving upon that is our priority.

SitePro products are sold through a network of dealers and distributors and also as private-labeled products. Please contact us with any questions or suggestions.

**CONTENTS**

OPTICAL INSTRUMENTS	4
LASER TOOLS & ACCESSORIES	7
DIGITAL LEVELS	11
PRISM SYSTEMS	12
TRIBRACH SYSTEMS	16
PRISM POLE SYSTEMS, RANGE POLES	17
GNSS ROVER RODS	20
BIPODS & TRIPODS, GPS TRIPOD	21
ACCESSORIES-PRISM, POLE, BIPOD	23
ACCESSORIES FOR GNSS, RODS	25
TRIPODS FOR INSTRUMENTS	26
LEVELING RODS	31
MEASURING DEVICES	34
MAGNETIC LOCATOR	36
HAND TOOLS	37
SHEATHS & POUCHES	39
SAFETY GEAR	40
WORK GEAR	42
FIELD SUPPLIES	48
BAGS AND CASES	53
ROTHBUCHER SYSTEMS	56

**SITEPRO BRANDS**

**GAMMON REEL®**

GAMMON REEL®, founded in 1962, provides line reels for both surveying and construction, as well as the GAMMAGNET® magnetic case for steel beam construction. GAMMON REEL is a well-known and respected brand in the surveying and construction industry.

**David White®**

David White®, founded in 1895 (Milwaukee, Wisconsin), provides productivity tools for leveling, layout and measuring in the construction and surveying industries. The David White brand is offered exclusively by Dave White's SitePro.



The SITEGEAR® brand is focused to provide best-in-class solutions for professionals in the construction and industrial market with workgear that works.



The SALAMANDER® brand is focused to provide professionals in the construction and industrial market with all-environment, high-visibility products.

**SITEPRO GUARANTEE**

Dave White's SitePro guarantees all our brands of tools and instruments against any defects in material or workmanship with a limited lifetime warranty.

For details and complete warranty, visit [www.dwsitepro.com/guarantee/](http://www.dwsitepro.com/guarantee/)

**VISIT OUR WEBSITE**

For more information about SitePro and Our Products visit [www.dwsitepro.com](http://www.dwsitepro.com)

Scan QR Code to download and view this catalog in electronic PDF format.



### APPLICATIONS

- Measure angles, establishing 90-degree reference lines
- Determine difference in elevation
- Check angles, alignment, and plumb
- Basic grade work
- Short range leveling
- Anchor bolt alignment
- Setting out curves
- Gravity flow pipe laser setup
- Aligning forms, walls





## DT8-05 DIGITAL TRANSIT THEODOLITE

The DT8-Series digital transit theodolite gives you accurate measurements for a wide range of construction and survey applications.

- Simple, push button function gives the user precise LCD digital readouts
- Incremental encoding detection system
- Front and back digital displays
- Coaxial tangent and clamp screws for sighting and alignment
- Automatic power shut-off
- Built-in easy access battery pack
- Water resistant, sealed construction



sku	what's included?
LASER PLUMMET <b>46-D8896</b> 	DT8-05LP Theodolites, sunshade, tool kit, rain cover, plumb bob, carrying case, rechargeable battery kit, alkaline battery tray, user guide
LASER SIGHT W/OPTICAL PLUMMET <b>46-D8897</b> 	DT8-05LS Theodolites, sunshade, tool kit, rain cover, plumb bob, carrying case, rechargeable battery kit, alkaline battery tray, user guide

<b>Magnification</b>	30x
<b>Field of View</b>	1° 30'
<b>Centering Plummet</b>	635nm laser, 2M
<b>Reading System</b>	Advanced absolute encoder
<b>Angular Precision</b>	5" (1 mgon)
<b>Minimum Reading</b>	1" / 5" switchable
<b>Units</b>	deg / mil / gon / V %
<b>Tilt Sensor</b>	Automatic compensation, ± 3' range

### 46-DT8EP DIAGONAL EYEPIECE

- Easily mounts to DT8- to measure angles and points in any direction
- Provides an erect image, and 1° 30' angle of view
- Measure any target with a distance of at least 4-1/4' (1.3m) from the instrument



Laser products are manufactured to Class 2M or 3R laser classification. Please refer to product warning labels for actual laser output and classification.

### APPLICATIONS

- Gravity flow pipe laser setup
- Measure angles, establishing 90-degree reference lines
- Anchor bolt alignment
- Aligning forms, walls



## LT8-300LTU UNIVERSAL LINE TRANSFER UNIT

The LT8-300LTU is versatile and ideal for use with pipe aligning laser or as a level-transit. The 360° telescope design allows direct sight below the instrument for pipe laying applications.

- Powerful 26X optics
- Accuracy: ±3/16-in at 150-ft (4.75mm at 45m)
- Range up to 400-ft (120m)
- Horizontal circle with lock
- Glass reticle with stadia lines for measuring distance (ratio 1:100)
- Plate vial for rough leveling and general plumbing requirements

sku	what's included?
NO PLUMMET <b>46-D8877</b>	LT8-300LTU Line Transfer Unit, rain hood, objective lens, case, user guide
LASER PLUMMET <b>46-D8879</b> 	LT8-300LTULP Line Transfer Unit, rain hood, objective lens, case, user guide



### APPLICATIONS

- Medium range leveling
- Turning angles, establishing 90° reference lines
- Determine vertical angles, basic grade work
- Checking angles, alignment, and plumb
- Anchor bolt alignment
- Gravity flow pipe laser setup
- Aligning forms, walls



## LT8-300 UNIVERSAL LEVEL-TRANSIT

The Dave White LT8-300 is rugged and dependable, making this five minute instrument the first choice for practically every horizontal and vertical sighting application in construction.

- Powerful 26X optics
- Accuracy: ±3/16-in at 150-ft (4.75mm at 45m)
- Range up to 400-ft (120m)
- Vertical arc and horizontal circle with locks and tangents
- 1:100 stadia with glass reticle

sku	what's included?
OPTICAL PLUMMET <b>46-D8871</b>	LT8-300P level-transit, plumb bob, rain hood, objective lens, case, user guide
LASER PLUMMET <b>46-D8872</b> 	LT8-300LP level-transit, plumb bob, rain hood, objective lens, case, user guide



David White Optical Instruments are guaranteed with a two (2) year limited warranty. Unless otherwise specified, hand levels and accessory items include a 90-day limited warranty.

### APPLICATIONS

- Turning horizontal angles, establishing 90° reference lines
- Medium range leveling
- Checking angles, alignment
- Determine difference in elevation
- Leveling forms and footers
- Measuring cut-and-fill



### APPLICATIONS

- Short range leveling
- Turning angles, establishing 90° reference lines
- Determine vertical angles, basic grade work
- Checking angles, alignment, and plumb



### APPLICATIONS

- Short range leveling
- Turning angles, establishing 90° reference lines
- Checking points in same horizontal plane
- Check elevations



David White Optical Instruments are guaranteed with a two (2) year limited warranty. Unless otherwise specified, hand levels and accessory items include a 90-day limited warranty.

## AL8-SERIES AUTOMATIC LEVELS

Make every leveling job faster and easier with David White automatic levels. Superior design sighting scope and bubble vial are built into the housing for greater durability.

- Lock-out device protects compensator during transport
- Larger aperture allows more light for a sharper image
- Soft control knobs for easier grip
- D8932 model features wedge hairs for improved reading accuracy
- Infinite tangent screw
- Horizontal circle with white on black graduations
- Wire-hung magnetically damped compensator holds the level line of sight within ±15 arc minutes of level



sku	what's included?	Magnification	Leveling Accuracy	Working Range
STANDARD KIT <b>45-D8926</b>	AL8-26 automatic level, adjustment tools, lens cap, plumb bob, case, user guide	26X	±1/16-in @ 100 ft (±1.5mm @ 30m)	300-ft (90m)
COMPLETE KIT <b>45-D8926K-1<sup>1</sup></b>	AL8-26 automatic level, adjustment tools, lens cap, plumb bob, case, user guide, <b>tripod, leveling rod</b>	26X	±1/16-in @ 100 ft (±1.5mm @ 30m)	300-ft (90m)
STANDARD KIT <b>45-D8932</b>	AL8-32 automatic level, adjustment tools, lens cap, plumb bob, case, user guide	32x	±1/32-in @ 100 ft (±1.0mm @ 30m)	400-ft (120 m)
COMPLETE KIT <b>45-D8932K-1<sup>1</sup></b>	AL8-32 automatic level, adjustment tools, lens cap, plumb bob, case, user guide, <b>tripod, leveling rod</b>	32x	±1/32-in @ 100 ft (±1.0mm @ 30m)	400-ft (120 m)

## LT6-900 22X MERIDIAN LEVEL-TRANSIT

Ideal for light construction work such as leveling, turning angles, and vertical angles.

- ±1/4-in at 100-ft (6mm at 30m) accuracy
- Cross hairs with 1:100 stadia lines allowing you to determine the distance
- Up to 200-ft (60m) range
- Horizontal circle graduated to 1°, reads by vernier direct to 15-minutes
- Vertical arc read to degrees (0-45°)
- Horizontal lock and tangent screw provides precise movement control
- Built-in sunshade
- Top mount leveling vial



sku	what's included?
STANDARD KIT <b>44-D8834</b>	LT6-900 transit-level, plumb bob, case, user guide
COMPLETE KIT <b>44-D8834K-1<sup>1</sup></b>	LT6-900 transit-level, plumb bob, case, <b>tripod, leveling rod</b> , user guide

## L6-20 22X MERIDIAN LEVEL

Designed for light construction work such as leveling and turning angles.

- ±1/4-in at 100-ft (6mm at 30m) accuracy
- Cross hairs with 1:100 stadia lines allowing you to determine the distance of the transit from the level rod
- Up to 200-ft (60m) range
- Horizontal circle graduated to 1°, reads by vernier direct to 15-min
- Top mount leveling vial
- Horizontal lock and tangent screw provides precise movement control
- Built-in sunshade for clearer sightings



sku	what's included?
STANDARD KIT <b>44-D8824</b>	L6-20 level, plumb bob, case, user guide
COMPLETE KIT <b>44-D8824K-1<sup>1</sup></b>	L6-20 level, plumb bob, case, <b>tripod, leveling rod</b> , user guide

<sup>1</sup> Complete kits available: include aluminum tripod and aluminum rod. Specify leveling rod graduations when ordering, add **C** for 8ths, **T** for 10ths. Example: 44-D8834-1T would include the 10ths leveling rod.

## 43-D620 2X SIGHTING HAND LEVEL

- Ideal for preliminary survey and simple distance estimation
- Sturdy impact resistant aluminum body and easy-to-read protected vial
- 2-power fixed magnification
- Pocket clip
- 90 day warranty





### APPLICATIONS

- Measure angles, establishing 90-degree reference lines
- Determine difference in elevation
- Check angles, alignment, and plumb
- Basic grade work
- Short range leveling
- Anchor bolt alignment
- Setting out curves
- Gravity flow pipe laser setup
- Aligning forms, walls



## DT-205 5-SEC DIGITAL THEODOLITE

The SitePro DT-205 digital theodolite gives you accurate measurements for a wide range of construction and survey applications.

- Simple, push button functions give the user precise LCD digital readouts
- Incremental encoding detection system
- Front and back digital displays
- Optical plummet - 3X power
- Coaxial tangent and clamp screws for sighting and alignment
- Automatic power shut-off
- Built-in easy access battery pack
- Water resistant, sealed construction

sku	what's included?
STANDARD KIT <b>26-DT205</b>	DT-205 Theodolite, sunshade, tool kit, rain cover, plumb bob, carrying case, rechargeable battery kit, alkaline battery tray, user guide

DT-205	
Magnification	30x
Field of View	1° 30'
Centering Plummet	3x optical
Reading System	Advanced absolute encoder
Angular Precision	5" (1 mgon)
Minimum Reading	1" / 5" switchable
Units	deg / mil / gon / V %
Tilt Sensor	Automatic compensation, ± 3' range



### APPLICATIONS

- Turning horizontal angles, establishing 90° reference lines
- Medium range leveling
- Checking angles, alignment
- Determine difference in elevation
- Leveling forms and footers
- Measuring cut-and-fill



## SK SERIES PRO AUTOMATIC LEVEL

This SitePro SK-Series professional automatic level features superior optics and excellent magnification with large aperture that allows more light for a sharper image.

- Magnetically dampened compensator quickly levels and stabilizes line of sight
- Cross hairs with 1:100 stadia lines
- Fine motion horizontal tangent knobs on left and right sides
- Solid base with three leveling screws
- 360° graduated horizontal circle in 1-degree increments
- Circular bubble vial can be easily viewed with 90-degree mirror
- Weather resistant- IP54

sku	what's included	magnification	accuracy	range	field of view	compensator range	wgt
STANDARD KIT <b>25-SK32X<sup>1</sup></b>	SK32X automatic level, adjustment tools, lens cap, plumb bob, case, user guide	32X	±1/16" @ 250-ft (±1.5mm @ 76m)	400-ft (120m)	1° 20'	±0.3", +/-15'	3.65lb (1.6kg)
STANDARD KIT <b>25-SK28X<sup>1</sup></b>	SK28X automatic level, adjustment tools, lens cap, plumb bob, case, user guide	28X	±1/16" @ 200-ft (±1.5mm @ 60m)	350-ft (105m)	1° 20'	±0.4", +/-15'	3.65lb (1.6kg)
STANDARD KIT <b>25-SK24X<sup>1</sup></b>	SK24X automatic level, adjustment tools, lens cap, plumb bob, case, user guide	24X	±1/16" @ 150-ft (±1.5mm @ 46m)	300-ft (90m)	1° 25'	±0.5", +/-15'	3.65lb (1.6kg)



### APPLICATIONS

- Short range leveling
- Turning angles, establishing 90° reference lines
- Determine vertical angles, basic grade work
- Checking angles, alignment, and plumb



## TL20X 20-POWER TRANSIT LEVEL

The TL 20X transit level is ideal for leveling and vertical applications.

- Fast set-up, simple to use
- Clamps and tangents bring your instrument quickly on target
- 3-screw leveling base with 5/8-11 thread for tripod
- Built-in sunshade with rubber eyepiece
- 15minute horizontal circle
- Stadia

sku	what's included	magnification	accuracy	range	field of view	wgt
STANDARD KIT <b>25-TL20X<sup>1</sup></b>	TL20X transit level, plumb bob, adjustment tools, case, user guide	20X	±1/4-in at 100-ft (6mm @ 30m)	200-ft (60m)	±2'/100-ft (±0.6m/30m)	2.95lb (1.3kg)



Dave White's SitePro Optical Instruments are guaranteed with a two (2) year limited warranty. Unless otherwise specified, accessory items include a 90-day limited warranty.

<sup>1</sup> Complete kits available: include aluminum tripod and aluminum rod. Specify leveling rod graduations when ordering, add C for 8ths, T for 10ths. Example: 25-SK32X-T would include the 10ths leveling rod.



### APPLICATIONS

- Adjusting and checking elevations
- General construction leveling such as concrete forms and footers
- Vertical alignment and plumb such as form alignment
- Dual grade and excavating
- Commercial and residential construction such as leveling & aligning walls, installing ceilings & floors



\*Detector may be different than shown.



### APPLICATIONS

- Interior & exterior, light to medium commercial, residential construction
- Leveling, alignment and squaring
- Checking elevations, footings, foundations
- Square and align walls, partitions, and corners
- Installing ceilings & floors



\*Detector may be different than shown.



Dave White's SitePro LR-Series and RL-Series Rotary Lasers are guaranteed with a two (2) year limited warranty. Unless otherwise specified, accessory items include a 90-day limited warranty.

## RL 322GR DUAL GRADE ROTARY LASER WITH VERTICAL ALIGNMENT

- Electronic self-leveling accuracy up to 3/32" at 100-ft (2.4mm at 30m)
- Working range up to 2,400-ft (730m)
- Ideal for both indoor and outdoor applications
- -7% to +7% in both X and Y axis dial-in grade (single slope: ±10.00%)
- Illuminated display for precise level, grade, and vertical alignment
- 90° layout beams, variable speed, scan angles, and beam positioning
- Smart H.I. Alert System stops rotating and alerts user when laser has been disturbed or drifts

sku	what's included?
STANDARD KIT <b>27-RL322GR</b>	RL 322GR Laser, RD 302 Detector, Rechargeable NiMH Battery Pack, Alkaline Battery Pack, Remote, Target, Glasses, Carrying Case, User Guide



Laser products are manufactured to Class 2M or 3R laser classification. Please refer to product warning labels for actual laser output and classification.

## LR 430HDV 3-D ROTARY LASER

- Leveling accuracy: 1/16-in at 100 feet (1.8mm at 30m)
- Working Range up to 2,950-ft (900m)
- Extremely high rotation speed
- Three integrated rotary heads
- Compact, ergonomic design with single button operation
- Multiple scan angles, beam positioning, and variable rotation speeds
- Single axis ±7.0% slope

sku	what's included?
STANDARD KIT <b>27-LR430HDV</b>	LR 430HDV rotary laser, laser detector, remote, universal mount, magnetic target, glasses, rechargeable battery/charger kit, 4-C <sup>1</sup> alkaline batteries, carrying case, user guide
COMPLETE KIT <b>27-LR430HDV-4<sup>1</sup></b>	LR 430HDV rotary laser, laser detector, remote, universal mount, magnetic target, glasses, rechargeable battery/charger kit, 4-C <sup>1</sup> alkaline batteries, carrying case, <b>tripod, leveling rod</b> , user guide



<sup>1</sup> Complete kits available: include aluminum tripod and aluminum rod. Specify leveling rod graduations when ordering, add **C** for 8ths, **T** for 10ths. Example: 27-LR430HDV-4T would include the 10ths leveling rod.

## Choosing The Right Rotary Laser.



	KS SERIES ROTARY LASERS			PRO SERIES ROTARY LASERS	
	KS 100H	KS 100HV	KS 100HVG	LR 430HDV	RL 322GR
<b>Leveling Accuracy</b>	±1/8" (±3mm)	±1/8" (±3mm)	±1/8" (±3mm)	±1/16" (±1.8mm)	±3/32" (±2.4mm)
Leveling Type	Electronic, ±5°	Electronic, ±5°	Electronic, ±5°	Electronic, ±4°	Electronic, ±5°
<b>Working Range (dia.)</b>					
without Detector	---	---	295-ft (90m)	65-ft (20m)	65-ft (20m)
with Detector	1,000-ft (305m)	1,000-ft (305m)	1,000-ft (305m)	2,950-ft (900m)	2,400-ft (730m)
<b>Functions</b>					
Slope/Grade	Dual Slope, -8.0%, +8.0%	Dual Slope, -8.0%, +8.0%	Dual Slope, -8.0%, +8.0%	Single Slope, ± 7.0%	Dual Dial-In, -10.0%, +10.0%
Scanning	---	Preset: 0°, 15°, 45°, 90°	Preset: 0°, 15°, 45°, 90°	Preset: 0°, 15°, 45°, 90°	Preset: 0°, 10°, 45°, 90°, 180°
Height Alert	Yes	Yes	Yes	Yes	Yes
Rotation speed(s)	600 rpm	150, 300, 600 rpm	150, 300, 600 rpm	400, 800, 2000 rpm	60, 120, 300, 600 rpm
<b>Power Supply</b>	4-C Alkaline	4-C Alkaline	4-C Alkaline, NiMH Battery	4-C Alkaline & Lithium Battery	4-C Alkaline & NiMH Battery
<b>Environment</b>	IP 54, Water/Dust Resistant	IP 54, Water/Dust Resistant	IP 54, Water/Dust Resistant	IP 55, Water/Dust Resistant	IP 65, Waterproof

APPLICATIONS

- Leveling, checking elevations, concrete forms
- Installation of decks, pools, drop ceilings, floors
- Excavating, digging footings, septic systems



APPLICATIONS

- Leveling, checking elevations, concrete forms, footings, foundations
- Estimating cut and fill
- Manual slope
- Installation of decks, pools, drop ceilings, floors
- Excavating, digging footings, septic systems



APPLICATIONS

- Leveling, checking elevations, concrete forms, footings, foundations
- Installing cabinets and finish carpentry
- Manual slope work
- Installation of decks, pools, drop ceilings, floors
- Excavating, digging footings, septic systems



**KS 100H**  
**BASIC HORIZONTAL ROTARY LASER**

Keep it simple with the KS 100H horizontal electronic self-leveling rotary laser for precise leveling applications.

- **Ideal for outdoor use**
- Simple button operation, easy to use
- ±1/8-in at 100-ft (3.0mm at 30m) leveling accuracy
- Up to 1000-ft (305m) working range
- Electronic self-leveling
- Dual axis slope (±8%) for simple slope applications
- Anti-Drift System alerts user when laser has been disturbed or drifts
- Enclosed Rotor Housing keeps laser safe from tough jobsite conditions

sku	what's included?
STANDARD KIT <b>27-KS100H</b>	KS 100H rotary laser, detector with bracket, alkaline battery compartment and batteries, case, user guide
COMPLETE KIT <b>27-KS100H-4<sup>1</sup></b>	KS 100H rotary laser, detector with bracket, <b>tripod, leveling rod</b> , alkaline battery compartment and batteries, case, user guide



**KS 100HV**  
**HORIZONTAL/VERTICAL ROTARY LASER**

- **Ideal for indoor and outdoor use**
- Horizontal and vertical electronic ±4° self-leveling
- Simple button operation, easy to use
- ±1/8-in at 100-ft (3.0mm at 30m) leveling accuracy
- Up to 1000-ft (305m) working range
- Dual axis slope (±8%) for simple slope applications
- Anti-Drift System alerts user when laser has been disturbed or drifts
- Enclosed Rotor Housing keeps laser safe from tough jobsite conditions

sku	what's included?
STANDARD KIT <b>27-KS100HV</b>	KS 100HV rotary laser, laser detector with bracket, remote, universal mount, magnetic target, glasses, 4-'C' alkaline batteries, carrying case, user guide
COMPLETE KIT <b>27-KS100HV-4<sup>1</sup></b>	KS 100HV rotary laser, laser detector with bracket, remote, universal mount, magnetic target, glasses, 4-'C' alkaline batteries, carrying case, <b>tripod, leveling rod</b> , user guide



**KS 100HVG**  
**HORIZONTAL/VERTICAL GREEN ROTARY LASER**

- **Ideal for indoor and outdoor use**
- Horizontal and vertical electronic ±4° self-leveling
- **4X** brighter and more visible than red beam lasers
- Simple button operation, easy to use
- ±1/8-in at 100-ft (3.0mm at 30m) leveling accuracy
- Up to 1000-ft (305m) working range
- Dual axis slope (±8%) for simple slope applications
- Anti-Drift System alerts user when laser has been disturbed or drifts
- Enclosed Rotor Housing keeps laser safe from tough jobsite conditions

sku	what's included?
STANDARD KIT <b>27-KS100HVG</b>	KS 100HVG rotary laser, laser detector with bracket, remote universal mount, magnetic target, glasses, NIMH rechargeable battery pack w/charger, alkaline batteries, carrying case, user guide
COMPLETE KIT <b>27-KS100HVG-4<sup>1</sup></b>	KS 100HVG rotary laser, laser detector with bracket, remote, universal mount, magnetic target, glasses, NIMH rechargeable battery pack w/charger, alkaline batteries, carrying case, <b>tripod, leveling rod</b> , user guide



 Laser products are manufactured to Class 2M or 3R laser classification. Please refer to product warning labels for actual laser output and classification.

Dave White's SitePro KS-Series Rotary Lasers are guaranteed with a one (1) year limited warranty. Unless otherwise specified, accessory items include a 90-day limited warranty.

<sup>1</sup> Complete kits available: include aluminum tripod and aluminum rod. Specify leveling rod graduations when ordering, add **C** for 6ths, **T** for 10ths. Example: 27-KS100H-4C would include the 6ths leveling rod.



APPLICATIONS

- Level, horizontal & vertical layout, square, & plumb
- Alignment of interior walls
- Drop ceiling or acoustical ceiling installation
- Cabinets & finish carpentry



**KS 2L**  
**CROSS LINE LAYOUT LASER**

The KS 2L projects a vertical and horizontal laser line, ideal for one person leveling, plumb, and layout applications.

- $\pm 1/8$ -in at 30-ft (3mm at 10m) leveling accuracy
- Up to 100-ft (30m) working range
- Small, compact design
- Detector mode allows laser to be used with optional line laser detector
- Adapter and support base with strong magnets, 1/4-20 and 5/8-11 thread, slots for screws or nails, raceways for optional straps
- Three modes of operation
- Easy access battery compartment
- Self-Leveling up to  $\pm 3^\circ$

sku	what's included?
<b>28-KS2L</b>	KS 2L laser, versatile mount, target, batteries, hard case, user guide



APPLICATIONS

- Level, horizontal & vertical layout, square, & plumb
- Layout, alignment, and squaring of interior walls
- Drop ceiling or acoustical ceiling installation
- Installation of recessed lighting, ductwork, plumbing
- Cabinets & finish carpentry



**KS2LG**  
**CROSS LINE LAYOUT GREEN BEAM LASER**

The KS 2L G projects a hi-vis green vertical and horizontal laser line, ideal for one person leveling, plumb, and layout applications.

- $\pm 1/8$ -in at 30-ft (3mm at 10m) leveling accuracy
- 4 times brighter than red beam lasers for better visibility
- Up to 100-ft (30m) working range
- Small, compact design
- Easy access battery compartment
- Detector mode allows laser to be used with optional green beam line laser detector
- Adapter and support base with strong magnets, 1/4-20 and 5/8-11 thread, slots for screws or nails, raceways for optional straps
- Self-Leveling up to  $\pm 3^\circ$

sku	what's included?
<b>28-KS2LG</b>	KS 2LG laser, versatile mount, target, batteries, hard case, user guide



APPLICATIONS

- Level, 90° layout, square, and plumb
- Layout and squaring interior walls and drywall track
- Point transfer
- Cabinet installation and finish carpentry



**KS5PG**  
**5-POINT GREEN BEAM LASER**

The simple to use KS 5PG is a green beam laser tool ideal for leveling, plumb, layout and squaring. Projects five 90° points for a wide range of applications.

- $\pm 1/4$ -in at 100-ft (3mm at 30m) accuracy
- Up to 100-ft (30m) working range
- Small, compact design
- Bright, highly focused green laser points
- Self-leveling spot beams up to  $\pm 6^\circ$
- Easy access battery compartment
- Includes UM1P multi-mounting device for quick positioning of the laser beams

sku	what's included?
<b>28-KS5PG</b>	KS 5PG laser, UM1P mount, target, batteries, hard case, user guide



KS-Series Layout Lasers are guaranteed with a one (1) year limited warranty. Accessory items include a 90-day limited warranty.

 Laser products are manufactured to Class 2M or 3R laser classification. Please refer to product warning labels for actual laser output and classification.



### RD105 COMPACT PRO LASER DETECTOR

- Front and rear LCD displays allow easy, fast visual detection of laser beam for exterior applications
- Automatic shut-off after 20-minutes without use
- Fine and coarse (2mm | 5mm at 50m) on-grade sensitivity settings for easy grade detection
- Strong built-in magnets on side and top
- Rugged housing and gasket seal (IP54)

sku	what's included?	Use with:
<b>27-RD105</b>	RD 105, rod clamp (#27-RB202), 4 AAA alkaline batteries	Most <b>Red</b> Beam Rotary Lasers
<b>27-RD105G</b>	RD 105G, rod clamp (#27-RB202), 4 AAA alkaline batteries	Most <b>Green</b> Beam Rotary Lasers



### RD302 LASER DETECTOR WITH DIGITAL READOUT

**NEW!**

- Ideal for basic and advanced leveling and alignment
- Digital readout displays elevation from on-grade within ±2 inches (±50cm)
- Large 5" capture height allows quick detection
- Units of measure: mm or inches
- Simultaneous elevation LED indicators on front for fast, easy visual
- Rugged housing and gasket sealed for water and dust protection (IP55)
- Strong built-in magnets on side and top
- Automatic shut-off

sku	what's included?	Use with:
<b>27-RD302</b>	RD 302, rod clamp (#27-RB202), 9v battery	Most <b>Red</b> Beam Rotary Lasers



Dave White's SitePro Laser Detectors are guaranteed with a one (1) year limited warranty.

### 27-BBMOUNT BEAM MOUNT CLAMPING SYSTEM

- Ideal for setting up instrument for vertical alignment application
- Securely attaches instrument to beam or joist up to 2.17-in (55mm)
- Removable 5/8-11 mounting plate easily fastens to instrument
- Fastener hole to ensure position of a theodolite's axis is precisely over point
- Weighs 2.43lb (1.10kg)



### 27-MT4 UNIVERSAL MULTI-MOUNT

- Ideal for drop ceilings, remodeling, and masonry
- Quick release push button
- Graduated scale (±2" and ±50mm markings) - 1/8" and millimeters with fine adjustment knob to precisely align laser to target
- Key slot to mount to a stud or wall using nail or screw
- Weighs 3.0lb (1.4kg)



### 27-4852-16 HEAVY-DUTY COLUMN CLAMP

- 12" (30.48cm) adjustable vertical column with 6" (15cm) flat platform, 5/8-11 thread stud
- Rubber bumper for hand and finger protection
- Heavy duty ratchet with 10-ft (3.05m) by 1-7/8" strap with load rating of 2,200lb (1,000kg).
- Center line of the 5/8-11 stud to column measures 15-in (38.1cm)
- Constructed of structural aluminum for industrial applications and stain-less steel hardware
- Weighs 13.8lb (6.25kg)



### BATTERY PACKS AND CHARGERS



46-DT805-CHARGER



27-LR4LIBATPK

sku	designed for
<b>27-LR4LIBATPK</b>	LI-ION Battery/Charger Kit for LR-Series Rotary
<b>27-SLRCHARGER</b>	Charger Kit for KS Series, LR322GR Rotary Laser
<b>27-SLRNIMHKIT</b>	NiMH Battery Pack/Charger Kit for KS 100 Series
<b>46-DT805-CHARGER</b>	Battery Charger for DT8-05, DT-205 Theodolite
<b>46-DT8BAT-NIMH</b>	NiMH Battery Pack for DT8-05 and DT-205 Theodolite
<b>46-DT8-BB</b>	Battery Box for DT8-05 and DT-205 Theodolites

### INSTRUMENT CASES PADDED STORAGE CASES

- For your SitePro and David White precision measuring instrument
- Durable outer shell and heavy duty protective padding



sku	designed for
<b>25-SPCASE-XP</b>	Hard Shell Padded Case for SK AutoLevel Series
<b>25-TL20X-CASE</b>	Hard Shell Case for TL20X, LT6-900 Transit
<b>27-LR4CASE</b>	Hard Shell Padded Case for LR4 Rotary Laser Series
<b>44-D8824-CASE</b>	Hard Shell Case for L6-20 Level
<b>26-DTCASE</b>	Hard Shell Padded Case for DT-205 and DT8-05 Theodolite



### APPLICATIONS

- Short to mid-range leveling for building and construction
- Elevation control
- Building and civil engineering
- Stakeout



11-805-BM barcode leveling rod is compatible with the SDL32



### SDL 32

FOCUS, MEASURE, DISPLAY RESULTS

NEW!

## 32-POWER DIGITAL AUTO LEVEL

Super fast measurement speed of less than 3 sec. with the simplicity of the one-push measure and store functionality provides faster, more economical workflow.

- One-Button Measuring: Accuracy of  $\pm 1.0\text{mm}$  for 1km double-run level. Simply press a button to take the measurement
- Range up to 100m (330-ft)
- Built-in memory for storing up to 1,000 points
- On-board software displays and calculates results for your application such as Line Leveling, Delta Height, Cut & Fill
- Interfaces with Micro-USB, Output to computer
- Data can be recorded on the job site and simply downloaded by connecting the SDL32 with a PC or laptop
- Shock-resistant pendulum magnetic damped compensator ensures durability and precision
- IP 55 water protection
- Horizontal circle- graduated to  $1^\circ$



sku	what's included	magnification	accuracy	range	field of view	compensator	wgt
STANDARD KIT <b>25-SDL32</b>	SDL 32 Digital Level, 5m barcode leveling rod, micro-USB cable, software, protective hard shell carrying case, user manual	32X	D $\leq 10\text{m} = < \pm 10\text{mm}$ ; D $> 50\text{m} = < \pm 0.2\%$ D	330-ft (100m)	$1^\circ 20'$	Range: $\pm 0.3^\circ$ , $\pm 15'$	4.2 lb (1.9kg)

## KS SERIES KEEP IT SIMPLE.

### DIGITAL LEVELS



### DL-SERIES

## DIGITAL LEVEL

- Precise digital measurements display in degrees, percent, or inches/feet
- Absolute and relative angle measurement
- High visibility LCD back-lit display with audible level and plumb indicator
- Reference function sets any slope to  $0.0^\circ$
- Digital measurement readout flips when upside down for ease of use
- Light weight, rugged precision machined aluminum construction
- Quick horizontal and vertical calibration
- Hold function locks measurement readout
- Includes: Digital level, AAA batteries, nylon padded case with carry strap, user guide



**Padded Carrying Case** is included with the Digital Level

	DIGITAL LEVELS	
	29-DL24	29-DL48
Length (Approx.)	24" (62cm)	48" (120cm)
Measuring Range	0-360° (4 x 90°)	
Measuring Accuracy	0° and 90°, $\pm 0.1^\circ$ ; -1° to 89°, $\pm 0.2^\circ$	
Weight	1.34lb (610g)	2.65lb (1200g)
Dimensions	23.7 x 2.6 x 1.2" (62 x 6.6 x 3cm)	47.3 x 2.6 x 1.2" (120 x 6.6 x 3cm)



Dave White's SitePro DL-Series Digital Levels are guaranteed with a one (1) year limited warranty. Unless otherwise specified, accessory items include a 90-day limited warranty.



**LCD BACK-LIT DISPLAY**  
with audible sound. Display readout rotates when measuring overhead



## 9300N

### 0/-30MM TILTING NITROGEN-FILLED PRISM SYSTEM

The advanced SitePro 9300 nitrogen (N<sub>2</sub>) sealed 0/-30mm prism system features a single tilting assembly with front lever locking mechanism to secure in position. This hi-performance prism system, precisely positioned in hi-grade aluminum holder ensures accurate measurement and is best for surveying.

- 62mm precision ground glass, up to 2 arc second accuracy
- Nitrogen sealed prism canister prevents condensation on glass lens
- Height of the prism in the holder is 100mm
- Front lever locking mechanism to secure prism in position
- 0/-30mm offset constant
- Dual-sided aluminum target 6.9" x 5.5" (17.6cm x 14cm)
- 5/8-11 stainless steel bayonet adapter (female thread)
- Includes prism, target and holder assembly, **21-1010 padded case**

sku	offset	prism type	prism size	target color	accuracy	axis height
<b>03-9300N-O</b>	0 / -30mm	nitrogen-filled	62mm	Flo-orange w/white 	≤2 sec	100mm



21-1010



## 1010 SERIES

### 0/-30MM SINGLE TILTING PRISM SYSTEM

The SitePro 1010-series tilting single prism system features a weather-proof sealed 2-1/2" prism, all-metal holder and 5.5 x 7-inch (14 x 17.8cm) target.

- 0/-30mm constant prism system, up to 5 second accuracy
- Weather-proof sealed 62mm precise glass prism
- Stainless steel tension knob to easily adjust target
- M20 x 2 mount thread, 5/8-11 bayonet adapter
- Includes prism, target and holder assembly, protective cap, **21-1010 padded case**

sku	offset	prism type	prism size	target color	accuracy	axis height
<b>03-1010-CC</b>	0 / -30mm	copper coated	62mm	flo-orange w/black 	≤5 sec	100mm
<b>03-1010-FC</b>	0 / -30mm	copper coated	62mm	flo-lime w/black 	≤5 sec	100mm
<b>03-1010-O</b>	0 / -30mm	standard	62mm	Flo-orange w/black 	≤5 sec	100mm
<b>03-1010-Y</b>	0 / -30mm	standard	62mm	Yellow w/black 	≤5 sec	100mm



03-1010-CC



21-1010

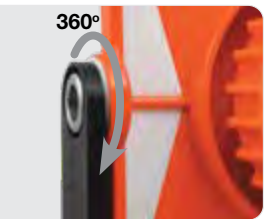

## 2010M SERIES

### SINGLE TILT PRISM SYSTEM, POLYCARBONATE

The SitePro 2010M series single tilting 0/-30mm prism system is an affordable high quality prism.

- 62mm precision ground glass, up to 2 arc second accuracy
- Single tilt holder tilts to 360 degrees with built-in peep sight for easy setup
- Can be mounted in either 0 or -30mm offset positions
- Height of the prism in holder is 120mm
- Nickel plated aluminum 5/8-11 bayonet adapter
- Fully compatible with leading manufacturers such as Sokkia, Trimble, Topcon, and other systems
- Prism canister and holder/target molded from durable lightweight polycarbonate, with metal yoke and nylon washer
- Includes: prism, target and holder assembly, protective cap, **21-2010 padded case**

sku	offset	prism type	prism size	target color	accuracy	axis height
<b>03-2010M-O</b>	0 / -30mm	standard	62mm	Flo-orange w/white 	≤5 sec	120mm



03-2010M-O



21-2010



## PRISM IN CANISTER

### 0/-30MM PRISMS

- Weather-proof sealed precise prism
- 62mm diameter prism
- M20x2 male mounting thread



03-2011-FC



03-2011-O

sku	dia (mm)	type	color	accuracy	replacment for models
<b>03-2011-FC</b>	62mm	copper coated	black	≤ 5"	1010, 2010M
<b>03-2011-O</b>	62mm	std	flo-orange	≤ 5"	1010, 2010M
<b>03-2011-Y</b>	62mm	std	flo-yellow	≤ 5"	1010, 2010M

## TILTING TARGET & HOLDER

These SitePro target and holder assemblies are tilting and ideal for night time or low-light work conditions.



03-1012-O



03-2012M-O

sku	description	color
<b>03-1012-O</b>	Target & holder with rear tension knob	Flo-orange/Black
<b>03-1012-Y</b>	Target & holder with rear tension knob	Flo-yellow w/Black
<b>03-2012M-O</b>	Poly target & metal holder with 360 degree tilting	Flo-orange/Black



## 3024

### 62MM SWISS-STYLE PRO PRISM SYSTEM WITH LARGE TARGET

- 62mm circular prism system is designed for high accuracy and maximum range
- High precision with less than 2" beam deviation
- 2.0mm centering accuracy, constant of 0mm
- Range up to 11,500 ft (3,500m)
- Copper coating with special resistant coating to prevent reflectivity caused by small particles or condensation
- Large removable aluminum target
- Includes: 3024 prism system; prism cap; padded case

sku	description	color	Tilt Height	Offset
<b>03-3024</b>	62mm Swiss-Style Pro Precision Prism System with Large Target	Black/Flo-green	86mm	Leica Offset: 0; Actual Offset: -34.4



## LPR121

### SWISS-STYLE PRO PRISM SYSTEM

- Built-in sight alignment
- High precision with less than 2" beam deviation, 2.0mm centering accuracy
- Copper coating with special resistant coating to prevent reflectivity caused by small particles
- Range up to 11,500 ft (3,500m)
- Mounted in metal holder with detachable target
- Includes: LPR121 prism system, cap, padded case

sku	description	color	Tilt Height	Offset
<b>03-LPR121</b>	Swiss-Style Pro Precision Circular Prism System	Black w/Flo-green side1, Flo-red side2	86mm	Leica Offset: 0; Actual Offset: -34.4





### 03-1518-R

## MINI PRISM STAKEOUT POLE SYSTEM

- 25mm precise mini prism with 0/-30mm offset tilting aluminum prism and holder
- Black anodized sealed aluminum can
- Two on-board circular bubble vials
- Four (4) precision machined sectional poles
- Includes prism system, four (4) sectional poles, point, adjustment tools, and case
- Weighs 1.7lb (0.77kg)



### 1500/1600

## 0/-30MM MINI PRISM SYSTEM

- 25mm prism, black anodized sealed aluminum can
- 5/8-11 mounting thread
- 40-min adjustable circular
- Includes: mini prism, prism holder, plumb bob prism point, S-hook, prism mount, 5/8-11 height extension, carrying case with belt loop



03-1500 Side mounted on-board vial

03-1600 Center mounted on-board vial

sku	prism size	prism type	vial	color
<b>03-1500-O</b>	25mm	Standard	Side Mounted	Orange
<b>03-1500-CC</b>	25mm	Copper Coated	Side Mounted	Orange
<b>03-1600-O</b>	25mm	Standard	Center Mounted	Orange



### 03-1558-RC

## MINI-PRISM WITH LARGE TARGET

- All anodized aluminum holder, target and can
- Tilting target, 0/30mm offset
- 25.4mm copper coated prism
- 5/8-11 mounting thread
- 40-min adjustable circular side-mounted vial
- Includes: plumb bob prism point w/ hook (#03-1507), bracket (#03-1516), 5/8-11 height extension, case



## MINI PRISM ACCESSORIES

sku	description	mount thread
<b>03-1511</b>	25.4mm Prism w/Canister	M6- male
<b>03-1507</b>	Plumb Bob Holder/Point & S-Hook	5/8-11
<b>03-1516</b>	Prism Mount, 0/-30mm Offset	M6- female



### 03-1520-OC

## STAKEOUT MINI-PRISM

- 25mm copper-coated mini prism
- 0/-30mm offset tilting prism assembly
- Top & bottom adjustable bubble vials
- Includes replaceable point, carrying case
- Weighs 0.9lb (0.41kg)



### 03-1700-B

## FIXED L-BAR 25MM MONITORING PRISM

- Ideal for surveying locations where a permanent mounting is needed
- 25mm copper-coated prism which is water and dust proof, 0mm offset
- Assembly made of black anodized aluminum, 10.3mm ID mounting hole

## RSZ-SERIES

### REFLECTIVE ADHESIVE TARGETS

- Recommended for carrying out distance measurements using a tachymeter or total station
- Reflective target with red crosshairs
- **Sheet of 10 targets (03-RSZ6-4 has 4 targets per sheet)**

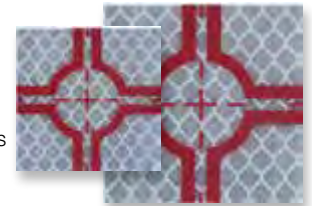

sku	contains	qty/sheet	range (approx)	target size
<b>03-RSZ2-10</b>	Sheet of 21mm Targets	10	50 m	21mm x 21mm
<b>03-RSZ3-10</b>	Sheet of 30mm Targets	10	80 m	30mm x 30mm
<b>03-RSZ4-10</b>	Sheet of 40mm Targets	10	100 m	40mm x 40mm
<b>03-RSZ6-4</b>	Sheet of 60mm Targets	4	120 m	60mm x 60mm

## RT-SERIES

### REFLECTIVE RETRO ADHESIVE TARGETS

- These self adhesive reflective targets can easily be seen in daylight
- 0 constant standard deviation at shortest target range 10m is less than 1.0mm
- Available in seven (7) different sizes, **Packaged with 10 targets**

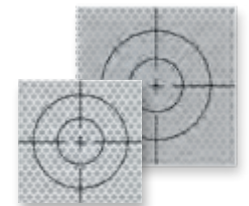

sku	contains:	qty/pack	range (approx.)	size
<b>03-RT20MM</b>	Package of 20mm Targets	10	50m	20mm x 20mm
<b>03-RT30MM</b>	Package of 30mm Targets	10	80m	30mm x 30mm
<b>03-RT40MM</b>	Package of 40mm Targets	10	100m	40mm x 40mm
<b>03-RT50MM</b>	Package of 50mm Targets	10	110m	50mm x 50mm
<b>03-RT60MM</b>	Package of 60mm Targets	10	120m	60mm x 60mm
<b>03-RT70MM</b>	Package of 70mm Targets	10	130m	70mm x 70mm
<b>03-RT90MM</b>	Package of 90mm Targets	10	140m	90mm x 90mm

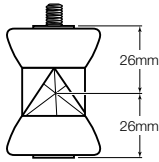

### 1360 360° MINI REFLECTOR SYSTEMS

- Compatible with Leica instruments and offsets
- +30mm constant
- Precise standards,  $\leq 5$  sec. accuracy
- Ideal for 360° surveying applications
- Includes 4-section pole set, mount with bubble vial, point, carrying case

sku	constant	accuracy	wgt
03-1360	+30mm	$\leq 5$ sec	1.7lb (.77kg)

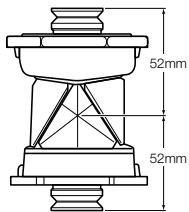

### ATP360 BUILDER SERIES 360° ROBOTIC PRISM

- -7mm constant
- Efficient solution compatible with Sokkia and Topcon robotic stations
- $\leq 5$  sec. accuracy
- Six (6) precision-machined cubes mounted in solid metal core housing
- 5/8-11 mounting thread on top and bottom

sku	constant	accuracy	wgt
03-ATP360	-7mm	$\leq 5$ sec	0.46lb (0.2kg)

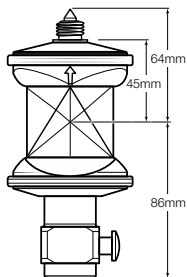

### GMAX360 360° ROBOTIC PRISM

- Compatible with Leica
- +23.1 constant
- $\leq 5$  sec. accuracy
- Six prisms are arranged to provide high pointing accuracy
- Working range up to 2000-ft (600m)
- Includes: 360 robotic prism, protective wrap, carrying case (#21-GMX360)

sku	constant	accuracy	wgt
03-GMAX360	+23.1mm	$\leq 5$ sec	0.46lb (0.2kg)

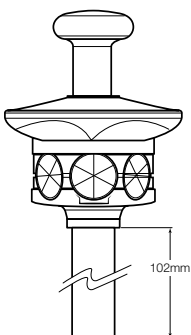

### 3600 360° ROBOTIC PRISM SYSTEM

- Precision 360° robotic prisms ensure tracking lock
- Compatible with Spectra
- Seven 25.4mm prisms;  $\leq 5$  sec. accuracy
- Includes 4" (102mm) height adapter system with 5/8-11 thread, padded carrying case

sku	constant	accuracy	wgt
03-3600	+2.0mm	$\leq 5$ sec	1.11lb (0.5kg)





## 05-1400-GY

### OPTICAL PLUMMET TRIBRACH

- High-precision, smooth locking mechanism with secure motion foot screws
- Access for Japanese Style EDM systems, electronic and optical theodolites
- Precise alignment of support cavity to the 5/8-11 threaded base plate assures accurate centering of instrument
- Circular vial with 10-minute/2mm sensitivity
- Push-pull slide focus
- Optical plummet— over point accuracy 0.5mm - 15m
- Weighs 1.85lb (0.84kg)



## 05-1300-B

### LASER TRIBRACH

- High-precision, smooth locking mechanism with secure motion foot screws
- Circular vial with 8-minute sensitivity
- Precise alignment of support cavity to the 5/8-11 threaded base plate assures accurate centering of instrument
- Laser plummet— accuracy 0.5mm - 15m
- Push-button switch located close to body prevents accidental powering on
- CR2 lithium battery (included) provides 10 hrs of continuous operation
- Weighs 2.2lb (0.98kg)



## 05-1201-B

### BASIC TRIBRACH

- Smooth locking mechanism
- 8-minute circular vial
- Precision aligned support cavity on 5/8-11 threaded base plate assures accurate centering of instrument
- Weighs 1.85lb (0.84k)



## 05-1200

### EUROPEAN OPTICAL PLUMMET TRIBRACH

- Smooth locking mechanism
- 8-minute circular vial
- Precision aligned support cavity on 5/8-11 threaded base plate assures accurate centering of instrument
- Optical plummet— over point accuracy 0.5mm - 15m
- Available colors: Black (-B) or Yellow (-Y)
- Weighs 1.85lb (0.84kg)



## 05-1200-BBAG

### TRIBRACH WITH CASE

- Protects tribrach during transport and storage
- Bag (21-1200) is also available separately (fits all 05-1200 model tribrachs)
- Size: 9" x 8.5" x 5.5"
- Includes: 05-1200-B Tribrach, Padded Case



## 2500 SERIES

### TRIBRACH ADAPTERS

- Anodized black aluminum
- 5/8-11 brass thread mounting
- Anodized aluminum mounting studs



05-2520



05-2521



05-2525

sku	style
05-2520	Fixed Tribach Adapter, 5/8-11 female thread
05-2521	Friction Type Rotating Tribach Adapter
05-2525	Zeiss/Wild Type Rotating Tribach Adapter, Adjustable

## 3511K

### TRAVERSE ADAPTER SYSTEMS

- For precise setups and traversing applications
- 2.5X optical plummet
- 60-second plate vial, adjustable
- Precision-machined axis rotates 360°
- Compatible with all prisms with a 24.9mm bayonet base
- Adjustable height: 100mm to 120mm
- Traverse tribrach adapter fits all standard three-prong tribrachs
- The over point accuracy is 0.5mm at 1.5m



## 21-3500

### PROTECTIVE HARD CASE

- Padded to protect instruments during transport and storage
- Carries your traverse kit
- Included with 05-3511K

sku	description
05-3511-K	Traverse Kit - Includes 05-3511 Tribrach Adapter, 05-1201-B Tribrach, 03-1010-O Prism System (Page 12), <b>21-3500 Padded Hard Case</b>
05-3511	Traverse Tribrach Adapter with Optical Plummet
21-3500	Padded Hard Case, for Traverse Kit
05-1200-B	European Optical Plummet Tribrach
03-1010-O	0/-30mm Single Tilting Prism System (Page12)





All SitePro rods and poles include carrying case with shoulder strap

Place your company logo and contact on poles. Ask for details.

**QuickTip™**  
Adapter Set Included



**QuickTip™**

## VERSATILITY ON THE JOBSITE

### ALL PRISM POLES INCLUDE THE UNIVERSAL ADAPTER SET

INCLUDED with 2.6m, 3.6m, and 4.65m Prism Poles

Includes QuickTip Adapters to set fixed height of pole for use with **Zeiss 360, CST 1010, SitePro 1010**, and others with target height of 100mm



QuickTip™ Adapter Set



#### 4700 SERIES

### TWIST LOCK PRISM POLE

- Designed for 5/8-11 QuickTip adapters for prism mounting (includes adapter set)
- Twist lock system with built-in 20-minute precise level vial
- The soft rubber knob is easy to tighten and loosen
- Inner aluminum pole with dual graduations: 10ths and metric
- Red/White aluminum outer pole
- Includes 07-2090-50A adapter, 07-2090-135A adapter, carrying case with shoulder strap

sku	length	inner grads	wgt	mounting type	sect.
<b>07-4708-TMA</b>	8.5-ft (2.6m)	10ths / metric	3.1lb (1.4kg)	5/8-11	2
<b>07-4712-TMA</b>	11.81-ft (3.6m)	10ths / metric	4.1lb (1.85kg)	5/8-11	3
<b>07-4715-TMA</b>	15.25-ft (4.65m)	10ths / metric	6.2lb (2.79kg)	5/8-11	4



QuickTip™ Adapter Set



#### 4700-FY SERIES

### HI-VIS TWIST LOCK PRISM POLE

- Designed for 5/8-11 QuickTip adapters for prism mounting (includes adapter set)
- Twist lock system with built-in 20-minute precise level vial
- The soft rubber knob is easy to tighten and loosen
- Inner aluminum pole with dual graduations: 10ths and metric
- High-visibility flo-yellow outer pole with anodized graduations in 10ths
- Includes 07-2090-50A adapter, 07-2090-135A adapter, carrying case with shoulder strap

sku	length	inner grads	wgt	mounting type	sect.
<b>07-4705-TMA-FY</b>	4.9-ft (1.49m)	10ths / metric	2.8lb (1.29kg)	5/8-11	3
<b>07-4708-TMA-FY</b>	8.5-ft (2.6m)	10ths / metric	3.1lb (1.4kg)	5/8-11	2
<b>07-4712-TMA-FY</b>	11.81-ft (3.6m)	10ths / metric	4.1lb (1.85kg)	5/8-11	3
<b>07-4715-TMA-FY</b>	15.25-ft (4.65m)	10ths / metric	6.2lb (2.79kg)	5/8-11	4



#### 4027

### 0.7M (2.3') MINI PRISM POLE

- Twist locking mechanism with built-in 20-minute vial
- 2-section aluminum pole system
- Replaceable hardened point
- Dual graduation: 10ths and metric
- 5/8-11 adjustable QuickTip™ adapter (#07-2090-135A) included
- Extended: 2.3-ft (70cm), collapsed: 19.5" (50cm)
- Includes carrying case with shoulder strap

sku	length	inner grads	wgt	mounting type	sections
<b>07-4027-TMA-FY</b>	2.3-ft (0.7m)	10ths / metric	1.23lb (0.56kg)	5/8-11, Adj.	2

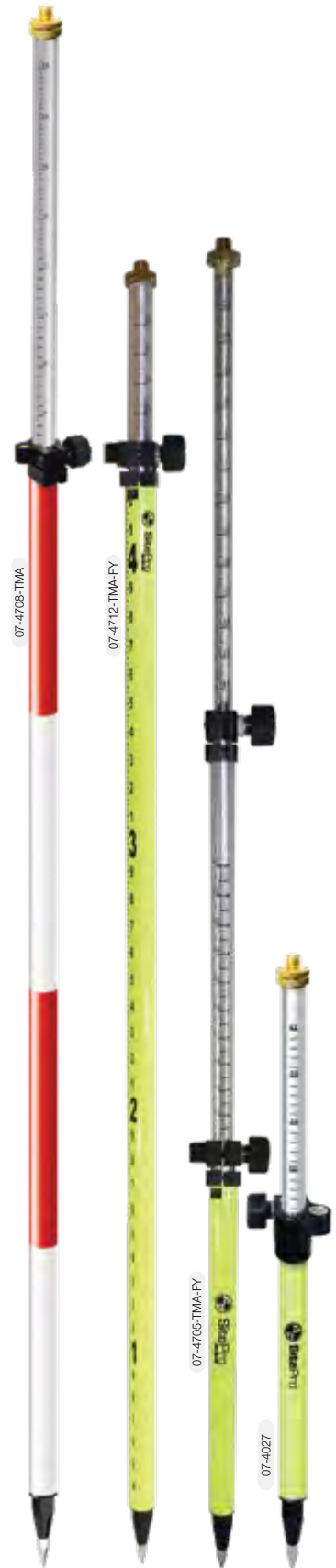



## 4700-SFY SERIES

NEW!

### 2.6M (8.5 FT) TWIST-LOCK PRISM POLE, HI-VIS FLO-YELLOW & METALLIC SILVER

- High-visibility flo-yellow outer pole with metallic silver stripes
- Twist lock system with built-in 20-minute precise level vial
- The soft rubber knob is easy to tighten and loosen
- Powder-coated and silk screened aluminum
- Inner aluminum pole with dual silk screened graduations: 10ths and metric
- Includes 07-2090-135A adjustable adapter, carrying case with shoulder strap

sku	length	inner grads	wgt	mounting type	sect.
07-4708-SFY	8.5-ft (2.6m)	10ths / metric	3.1lb (1.4kg)	5/8-11	2



### SURVEYOR COMBO KIT WITH PRISM, 8' (2.6M) PRISM POLE, AND BIPOD

NEW!

- Complete surveyor's kit that provides the essential accessories for precise accurate measurements
- Ships In One (1) Box: 56-in x 10.5-in x 10-in (142.3 x 27 x 25.5 cm), Weighs 17 lb (7.75 kg)

sku	includes	wgt
07-1010PBK	1010-O prism with padded case, 4708-SFY 2.6M (8-ft) prism pole with case, 4360-FY aluminum bipod with case with shoulder strap	3.1lb (1.4kg)

## 4001

### MINI STAKEOUT POLE, 1.28 FT

- One-piece aluminum pole system
- Point can be removed to use as a pole extension, 1-1/4" outside diameter
- Built-in 20-minute precise level vial
- Includes replaceable hardened prism pole point

sku	length	wgt	mounting type	sections
07-4001-FY	1.28-ft (0.39m)	1.5lb (0.68kg)	5/8-11, Fixed	1

## 4047

### 4.7" MINI HANDHELD ROD

The SitePro mini handheld rod features a 5/8-11 threaded stud with adjustable bubble vial. Use with any prism system that fits the 5/8-11 male thread.

- Height of 4.7 inches (120mm)
- Built-in adjustable 20-minute circular bubble vial
- Removable tip
- Carrying case not available

sku	length	material	wgt	mounting type
07-4047	4.7" (120mm)	Aluminum	0.4lb (0.18kg)	5/8-11, Fixed

## 5100 SERIES

### POLE EXTENSIONS, ALUMINUM

The 5100 Series aluminum pole extensions have 5/8-11 female threads on the bottom and 5/8-11 male threads on the top to allow more added sections.

- 1.25" (32mm) outside diameter
- High-visibility flo-yellow
- Various sizes available

sku	length	type	weight
07-5130-FY	1-ft	Aluminum	1.00lb (0.45kg)
07-5143-FY	1M	Aluminum	1.30lb (0.59kg)
07-5144-FY	50cm	Aluminum	1.00lb (0.45kg)
07-5145-FY	25cm	Aluminum	0.90lb (0.41kg)

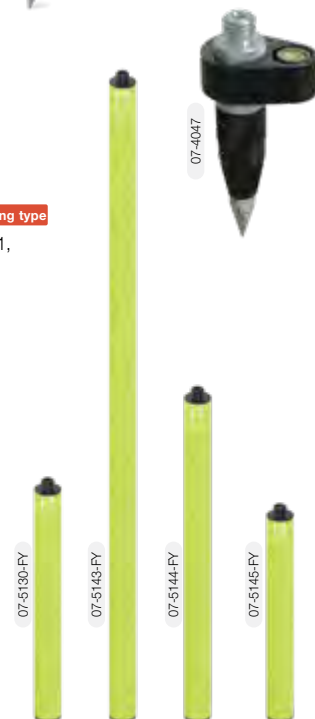



Includes 50mm Height Adapter

### 4602-TM

IMPROVED! NOW WITH 2.0M LOCKING PIN POSITION

## 8.6-FT CARBON FIBER ROBOTIC POLE

Designed to work with the Topcon®-style 360-degree prism and remote control. An essential accessory for the Topcon-style robotic total stations.

- Carbon fiber outer pole, dual graduation (0.01-ft/ 0.1cm); black aluminum inner pole, dual graduation (0.01-ft/ 0.1cm) for direct reading
- Locking pin secures pole to prevent slipping of pole section
- 5/8-11 thread fixed male tip
- Built-in 20-minute bubble vial
- Soft grip twist-lock knob tightens and loosens easily to secure two sections
- Includes 50mm adapter, carrying case

sku	grads	lengths	inner pole	locking pin positions	wgt
<b>07-4602-TM</b>	Dual	4.90 to 8.60-ft (1.52 to 2.60m)	Aluminum	<b>2.0M</b> , 5.5-ft, 6.0-ft, 6.5-ft, 7.0-ft, 7.5-ft, 8.0-ft, 8.5-ft	2.5lb (1.2kg)

## THE ULTIMATE TOPOGRAPHIC POLE



QuickTip™ Set



### 4626-TM

## TOPOGRAPHIC QUICKTIP™ CARBON FIBER PRISM POLE

Lightweight, rugged and weatherproof versatile pole designed for professional surveyors to quickly adapt for GPS, robotic, or total station surveying. Features inner aluminum pole with dual graduations, easy grip twist-lock with locking pin mechanism and QuickTip system.

- Carbon fiber pole with aluminum inner pole, dual graduation (0.01-ft/ 0.1cm)
- Interchangeable QuickTip adapters to achieve correct target height
- Locking pin secures pole to prevent slipping of pole section
- Built-in 20-minute bubble vial
- Soft grip twist-lock knob tightens and loosens easily to secure two sections
- Compatible with most targets, prisms, or GPS antennas
- Includes carrying case, 2090-135A universal adjustable adapter, and 2090-150 GPS mounting adapter

sku	grads	lengths	inner pole	locking positions	adapter included	wgt
<b>07-4626-TM</b>	Dual	1.52 to 2.60m (4.97 to 8.53-ft)	Aluminum	1.8m, 2.0m, 2.2m, 2.4m	2090-135A, 2090-150	2.5lb (1.2kg)

### 3812/3912

## 3.6M RANGE POLE

- Lightweight, 3-section with point
- Available in aluminum or composite with steel point
- 4-ft sections with alternate white & red striping
- Three (3) 1-1/4 inch (32mm) diameter poles with 5/8-11 male and female thread metal inserts
- Model 3812 includes carrying case and rubber boot

sku	length	material	locking	wgt	mounting type	sections
<b>09-3812</b>	Fixed, 3.6m (12-ft)	<b>Aluminum</b> Red/White	5/8-11	3.4lb (1.54kg)	5/8-11, Adj. H.I.	3
<b>09-3912</b>	Fixed, 3.6m (12-ft)	<b>Composite</b> Red/White	5/8-11	2.0lb (0.91kg)	5/8-11, Adj. H.I.	3



90 day guarantee on all poles

All SitePro rods and poles include carrying case with carrying strap

Place your company logo and contact on poles. Ask for details.

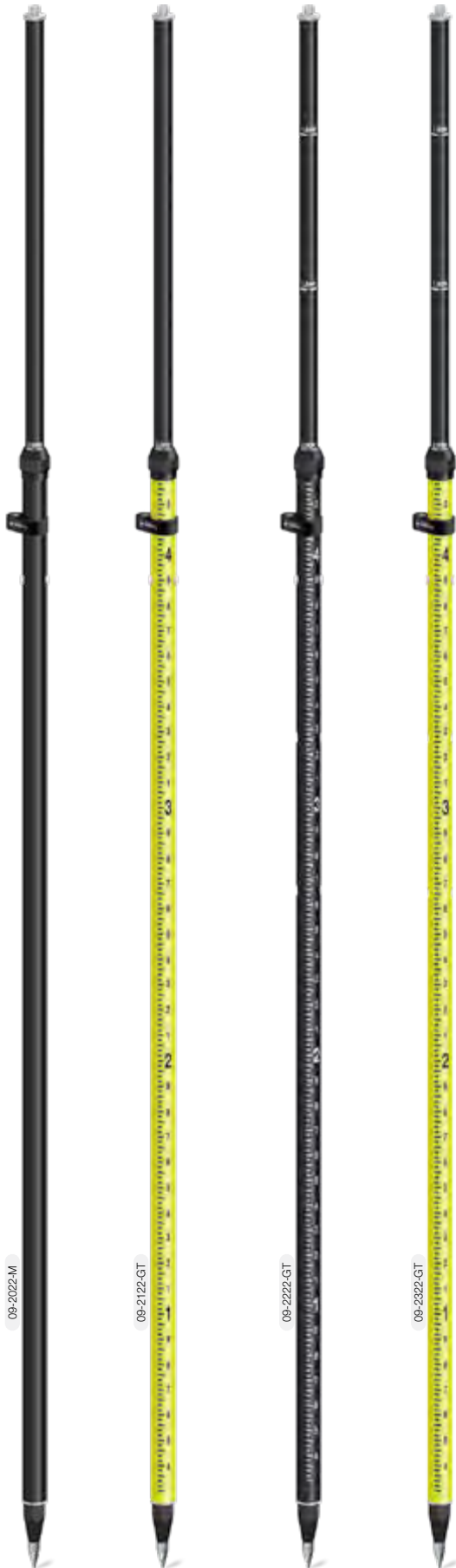

## 2022

### 2 METER CARBON FIBER SNAP-LOC ROVER ROD

- Snap-loc for non-slip positioning, secures height at 2.0m
- Compression lock mechanism
- On-board 20-minute, adjustable circular vial
- Lightweight telescoping 2-section pole



sku	length	heights	material	grads	wgt
09-2022-M	2.0m	2m, Collapses to 4.5-ft (1.37m)	Carbon Fiber, Black	n/a	1.8lb (0.82kg)

## 2122

### 2 METER ALUMINUM SNAP-LOC ROVER ROD

- Snap-loc for non-slip positioning, secures height at 2.0m
- Compression lock mechanism
- On-board 20-minute, adjustable circular vial
- Lightweight telescoping 2-section pole



sku	length	heights	material	grads	wgt
09-2122-GT	2.0m	2m, Collapses to 4.5-ft (1.37m)	Aluminum, Fluorescent	10ths 100ths	2.4lb (1.09kg)

## 2222

### 3-POSITION CARBON FIBER SNAP-LOC GPS ROVER ROD

- Lightweight 2-section telescoping **carbon fiber** rod
- Snap-loc for no slip with compression lock - 3 height positions: 2m, 1.8m or 1.6m and collapses to 4.5-ft (1.37m)
- On-board 20-minute, adjustable circular vial



sku	length	heights	material	grads	wgt
09-2222-GT	2.0m	1.6m, 1.8m, 2m; Collapses to 4.5-ft (1.37m)	Carbon fiber	10ths 100ths	1.8lb (0.82kg)

## 2300

### 3-POSITION ALUMINUM SNAP-LOC GPS ROVER ROD

- **All-aluminum** 2-section telescoping rod
- Snap-loc for no slip with compression lock - 3 height positions: 2m, 1.8m or 1.6m and collapses to 4.5-ft (1.37m)
- On-board 20-minute, adjustable circular vial



sku	length	heights	material	grads	wgt
09-2322-GT	2.0m	1.6m, 1.8m, 2m; Collapses to 4.5-ft (1.37m)	Aluminum	10ths 100ths	2.2lb (0.99kg)

90 day guarantee on all poles

All SitePro rods and poles include carrying case with carrying strap

Place your company logo and contact on poles. Ask for details.



### 2002 / 2102

## 2M TWO-PIECE GNSS ROVER ROD

- Available in lightweight carbon fiber or aluminum model
- Model 2102-M features cable slots to protect the connection cable(s)
- Fixed height at two (2) meters
- Built-in on-board 20-minute, adjustable circular vial
- Easy soft-grip

sku	length	color	material	mounting type	wgt	sections
09-2002-M	Fixed 2.0M (6.56-ft)	Black	Carbon fiber	5/8-11, Fixed	1.76lb (0.80kg)	2
09-2102-M	Fixed 2.0M (6.56-ft)	Flo-Yellow	Aluminum	5/8-11, Fixed	4.0lb (1.81kg)	2



### 100 SERIES

## GPS ANTENNA TRIPOD

The SitePro 100S GPS antenna tripod, ideal for GPS and machine-control applications, features aluminum construction with extendable tripod legs and 2 meter center staff with twist-lock mechanisms.

- Center staff rotates 360° to check calibration of plumb
- Built-in 8-minute bubble vial
- 3-position center staff with steel locking pin adjusts to 3 heights: 2.0m, 1.8m, 1.5m
- Lightweight, heavy duty aluminum legs and staff are electrostatically powder-coated in flo-lime paint
- Aluminum hardware is anodized black
- Large attachable soft-turf spurs (included) for more grip to maximize stability in soft-ground applications and prevent twisting, ideal when using angle measuring instruments such as robots
- Built-in compass with 8-minute vial
- Removable 5/8-11 threaded head adapter
- Replaceable points
- Includes **LGSPUR** Soft-Turf Spur Set, **21-81540 heavy bag**



21-81540

sku	locking type	center locking	open	collapsed	wgt
09-100S-FY	Twist Lock	2.0m, 1.8m, 1.5m	79" (201cm)	50" (127cm)	15lb (6.8kg)



Large spur (included) attaches to add grip to maximize stability in soft-ground applications

### 4250

## THUMB-RELEASE TRIPOD WITH TOP ENTRY

- Tripod creates free-standing setup for GNSS antenna poles or prism poles
- Top mount universal head will accommodate 1 to 1.25-inch diameter
- Features large, thumb release buttons for quick setup on even or uneven ground
- Impact resistant materials, replaceable shoes, and quick release telescoping aluminum legs
- Legs extend independently up to 6-ft (180cm)
- Fine adjustment knob for fine tuning your setup
- Includes carrying case

sku	type	color	style	open	collapsed	wgt
07-4250	Aluminum	Flo-Yellow	Thumb Release	71" (180cm)	42-1/2" (108cm)	6.0lb (2.72kg)

Open-Top Clamping System

07-4250



### 4260

ANTI-CRUSH

## V-SERIES ANTI-CRUSH THUMB-RELEASE BIPOD

The SitePro 4260 is designed to provide non-slip grip while preventing user from over-tightening clamp and crushing the prism pole. Used by a surveyor to set up a freestanding GPS antenna pole or prism pole. Easy grip twist-lock for securing pole.

- Open-Side Clamping System
- Anti-Crushing
- Fits 1" to 1.5" Poles

- Side-entry head with open clamp for quick and easy pole setup
- Reinforced feet with replaceable points
- Unique locking system provides non-slip quick clamping
- Easily adjust height of legs independently with thumb release push buttons
- Fits 1" to 1-1/2" (25mm-38mm) diameter poles
- Includes velcro strap to secure legs during transport

sku	type	color	style	fits (pole diameter)	open	closed	wgt
07-4260	Aluminum	Flo-Yellow	Open-Side, Anti-Crush	1" to 1-1/2" (25mm-38mm)	71-1/2" (182cm)	42-1/2" (108cm)	4.3lb (1.95kg)



### 4364

ANTI-CRUSH

## ALUMINUM ANTI-CRUSH THUMB-RELEASE BIPOD

The SitePro 4364 is designed to provide non-slip grip while preventing user from over-tightening clamp and crushing the prism pole. Used by a surveyor to set up a freestanding GPS antenna pole or prism pole. Fits 1 to 1.25 inch (25.4 to 32mm) outside diameter poles easily through the open-face head with anti-crush clamp. 1.5-in (38mm) poles can be attached easily through the top of the open face clamp.

- Open-Face Clamping System
- Anti-Crushing
- Fits 1" to 1.5" Poles

- Open-face head with anti-crush clamp for quick and easy pole setup
- Unique anti-crush locking system provides non-slip quick clamping
- Fits 1" to 1-1/2" (25mm-38mm) diameter poles
- Easily adjust height of legs independently with thumb release push buttons
- Replaceable points
- Includes velcro strap to secure legs during transport

sku	type	color	style	fits (pole diameter)	open	closed	wgt
07-4364-FY	Aluminum	Flo-Yellow	Open-Face, Anti-Crush	1" to 1-1/2" (25mm-38mm)	71" (182cm)	42" (108cm)	4.7lb (2.13kg)



### 4360

## ALUMINUM THUMB-RELEASE BIPOD

Easily set up a freestanding GPS antenna pole or prism pole. Fits 1 to 1.25 inch (25.4 to 32mm) outside diameter poles easily through the side entry head with open clamp. 1.5-inch (38mm) poles can be attached easily through the top of the open clamp.

- Open-Side Clamping System
- Fits 1" to 1.5" Poles

- Side-entry head with open clamp for quick and easy pole setup
- Unique locking system provides non-slip quick clamping
- Easily adjust height of legs independently with thumb release push buttons
- Fits 1" to 1-1/2" (25mm-38mm) diameter poles
- Replaceable points
- Includes velcro strap to secure legs during transport

sku	type	color	style	fits (pole diameter)	open	closed	wgt
07-4360-FY	Aluminum	Flo-Yellow	Open-Side	1" to 1-1/2" (25mm-38mm)	70" (178cm)	42" (108cm)	4.7lb (2.13kg)
07-4360-Y	Aluminum	Yellow	Open-Side	1" to 1-1/2" (25mm-38mm)	71" (182cm)	42" (108cm)	4.7lb (2.13kg)



90 day guarantee on all poles

All SitePro bipods include carrying case with carrying strap

Place your company logo and contact on poles. Ask for details.



- Open-Face Clamping System
- Anti-Crushing
- Fits 1" to 1.5" Poles

### 4365 ANTI-CRUSH THUMB-RELEASE BIPOD

**ANTI-CRUSH**

The SitePro 4365 is constructed of carbon fiber and used to quickly set up a freestanding GPS antenna pole or prism pole.

- Open-face head with anti-crush clamp for quick and easy pole setup
- Unique locking system provides non-slip quick clamping
- Fits 1.0 to 1.5-in (25.4 to 38mm) outside diameter poles easily through the open-face entry head
- Easily adjust height of legs independently with thumb release push buttons
- Replaceable points
- Includes velcro strap to secure legs during transport

sku	type	color	style	fits (pole diameter)	open	closed	wgt
07-4365	Carbon Fiber	Black	Open-Face, Anti-Crush	1" to 1-1/2" (25mm-38mm)	71-1/2" (182cm)	42-1/2" (108cm)	4.1lb (1.86kg)



- Open-Side Clamping System
- Fits 1" to 1.5" Poles

### 4360-05 THUMB-RELEASE MINI BIPOD

This Mini Bipod utilizes the same style as the 07-4360 series bipod, but shorter.

- Fits 1.0 to 1.5" (25.4 to 38mm) diameter poles easily through the open clamp
- Collapses to 25-inches (63.5cm) and extends to 35-inches (88.9cm)
- Replaceable points
- 1.5-inch (3.81 cm) outside diameter poles can be loaded through the top

sku	type	color	style	fits (pole diameter)	open	closed	wgt
07-4360-05-FY	Aluminum	Flo-Yellow	Open-Side	1" to 1-1/2" (25mm-38mm)	35" (90cm)	25" (64cm)	3.5lb (1.6kg)



- Open-Side Clamping System
- Fits 1" to 1.5" Poles

### 4160 FIXED MINI PRISM POLE BIPOD

A simple mini bipod, ideal for use with poles under 24-in (61cm) long. The legs are a fixed length of 10-inches (25cm) each.

- Side-entry head with open clamp for quick and easy pole setup
- Unique locking system provides non-slip quick clamping
- Fits 1.0 to 1.5-in (25.4 to 38mm) diameter poles easily through the open clamp
- Legs are made of solid aluminum at a fixed height of 10-in (25cm)

sku	type	color	style	fits (pole diameter)	open	closed	wgt
07-4160	Aluminum	Black	Fixed Height	1" to 1-1/2" (25mm-38mm)	10" (25cm)	n/a	0.8lb (0.36kg)



## 2090 SERIES QUICKTIP™ POLE ADAPTERS

- Precision machined aircraft aluminum
- 5/8-11 male pole mounting thread
- Compatible with the QuickTip™ series poles and other prism poles with this type of interchangeable design
- Adapters length is designed to achieve 150mm target height

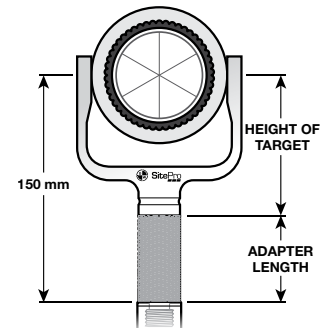
**QuickTip™**

sku	target(s) designed for	target height	adapter 'L'	sku	target(s) designed for	target height	adapter 'L'
07-2090-100	Topcon APT1 and APT2	50mm	100mm	07-2090-35	SitePro 2010M	115mm	35mm
07-2090-135A	5/8-11 Adj. Adapter	50-135mm	n/a	07-2090-50	GPH1, SitePro 03-3024	86mm	50mm
07-2090-15	Trimble RMT	135mm	15mm	07-2090-50A	Zeiss 360° Prism, CST 1010	100mm	50mm
07-2090-150	GPS Antenna	0mm	150mm	07-2090-73	TopCon 360 Prisms	77mm	73mm



### 09-114-10

#### TRIPLE MAGNET MOUNT FOR R10

- Light-weight magnetic bracket for GNSS antennas on the roof of vehicles
- Spring design for greater flexibility
- Three (3) very strong 4.5-inch (115mm) diameter magnets to ensure a stable position of the antenna
- 5/8-11 thread connector for mounting GNSS antenna
- 6.375-inches (162mm) in height
- Includes mount and extra-tall adapter
- Weighs 3.75lb (1.70kg)



### 09-114-050

#### SINGLE MAGNETIC MOUNT WITH 5/8-11 TIP

- Strong magnetic base with 3.5-in (90mm) diameter
- 5/8 x 11 tip
- Weighs 1.17lb (0.53kg)



### 07-2131

#### ADAPTER 5/8 FEMALE TO 1/4 MALE

- Features 5/8-11 female to 1/4-20 male
- Weighs 0.17lb (0.08kg)



### 07-5180

#### ADAPTER DOUBLE MALE

- 5/8-11 double male adapter
- Weighs 0.08lb (0.04kg)



### 07-5181

#### ADAPTER DOUBLE FEMALE

- 5/8-11 double female adapter
- Weighs 0.08lb (0.04kg)



### 07-2090-012

#### ADAPTER GPS QUICK-RELEASE TIP

- Quick-release Swiss-style tip
- Male 5/8-11 threads
- Weighs 0.08lb (0.04kg)



### 07-2080

#### SNAP-ON TYPE PRISM ADAPTER

- Adapter for Swiss-style snap-on prisms
- Mounts to 5/8-11 tribrach adapter or prism pole
- Weighs 0.06lb (0.03kg)



### 07-PS4000

NEW!

#### PRISM POLE SHOE W/POINT

- Designed for prism poles and bipods
- Anodized aluminum body
- 5/8-11 female thread
- Easy to replace sharp steel point
- Height: 3.37-in (85.6mm)
- Weighs 1.26lb (0.57kg)



### 07-191-A

#### PRISM POLE TOPO SHOE

- Precision machined aluminum body with 1-in (25.4mm) base
- 5/8-11 female thread
- Height: 3.37 in (85.6mm); Weighs: 0.34lb (0.16kg)



### 07-191-B

#### PRISM POLE TOPO SHOE

- Aluminum body with 2.5-in (64mm) wide base
- 5/8-11 female thread
- Height: 3.37-in (85.6mm); Weighs 1.26lb (0.57kg)



### 07-2090-76

#### GPS QUICK-DISCONNECT 76.2MM ADAPTER

- Anodized aluminum adapter with leica-style connector on the bottom, 5/8-11 thread on the top
- Can be combined with #2090-24 for quick release adapter
- Adds\* 76.22mm to GNSS or prism pole
- Weighs 0.14lb (0.06kg)



### 07-2090-24

#### GPS QUICK-RELEASE ADAPTER

- Anodized aluminum adapter with female 5/8-11 thread on the bottom, leica-style connector on the top
- Adds\* 24mm to your GNSS or prism pole length
- Weighs 0.05lb (0.02kg)



\*Note: consider heights in your software or when post-processing your data in the office.



**5200 SERIES**

**SUREGRIP QUICK RELEASE CRADLES**

The SureGrip quick release cradles feature a clamping system that easily secures data collector/controller without crushing it.

- Anti-crush quick release design locks cradle securely when tightened
- Plugs directly into quick-release pole clamps
- Easily secures data collector/controller with anti-crush quick release design that locks cradle when tightened
- Durable anodized aluminum design
- Includes replaceable silicone pads that hold the controller securely



item	designed to fit	wgt
<b>10-52139</b>	Ranger 7™, TSC 7™	0.55lb (0.25kg)
<b>10-5265</b>	TSC3	0.46lb (0.21kg)

item	designed to fit	wgt
<b>10-5274</b>	Surveyor 2, Allegro 2	0.49lb (0.23kg)
<b>10-5277</b>	MESA 2, FC-5000, RT3	0.45lb (0.20kg)

**5246C**

**NEW!**

**SUREGRIP SYSTEM FOR TSC5**

This SureGrip quick release clamping system features a clamping system that easily secures data collector/controller without crushing it.

- Designed for the TSC5 Controller
- Made of durable machined and anodized aluminum and stainless steel construction
- Easily secures data collector/controller with anti-crush quick release design that locks cradle when tightened
- Quick release clamp fits 1.25-in (32mm) pole and has six tilt positions



item	designed to fit	wgt
<b>10-5246C</b>	TSC 5™	0.74lb (0.34kg)

**Design Your Own Custom Solution for Securing Your Data Collector or Controller**



**OCP SERIES**

**OPEN CLAMP BRACKETS**

- Designed for efficient mounting to poles and rods
- Made of aluminum for durability and performance
- Quick-release button allows a quick-release cradle to rotate in a comfortable position
- Compatible with SureGrip and most competitor's cradles

sku	description	fits (dia.)
<b>10-5194</b>	OCP Bracket with Compass	1.25-in (32mm)
<b>10-5198</b>	OCP Bracket with 0.15 x 0.92" Slot for Radio	1.5-in (38mm)
<b>10-5199</b>	OCP Bracket with 0.15 x 0.92" Slot for Radio	1.25-in (32mm)

**QR SERIES**

**QUICK RELEASE CLAMPS**

- Easily secures to pole with special design to prevent overtightening the pole clamp screw
- Ideal for RTK and GNSS surveys requiring a pole and a data collector
- Made of anodized aluminum for durability and performance
- Compatible with most popular quick-release cradles to hold data controllers

sku	description	fits (dia.)
<b>10-5215</b>	QR Pole Clamp	1.25-in (32mm)
<b>10-5215X</b>	QR Pole Clamp w/20-min Vial & Compass	1.25-in (32mm)
<b>10-52154</b>	QR Pole Clamp with Compass	32mm (1.25-in)

**BAS SERIES**

**BALL & SOCKET SYSTEMS**

- Ball and socket link system is designed to allow versatile positioning of the controller position on the pole
- Easily secures data collector/controller with anti-crush quick release design that locks cradle when tightened
- Quick-release pole clamp
- Durable anodized aluminum design

sku	description	fits (dia.)
<b>10-52160</b>	BAS Pole Clamp	1.25-in (32mm)
<b>10-52201</b>	BAS Link	1-in (25.4mm) Ram Ball



11-750

### ROD LEVEL

- Fits round or rectangular rods for quick setup of your leveling rod with convenience
- Strong die-cast aluminum housing and adjustable vial
- Strong aluminum housing, quickly level your leveling rod with convenience
- Large, easy to read 30-min bubble vial
- Works with all leveling staffs and prism poles
- Mounting hardware included



11-751

### HEADS UP ROD LEVEL

- Specially designed for safety while performing routine surveys in traffic areas
- Clamps onto a rod up to 1.25-in (32mm) diameter and allows user to simply look through the side window to check level while keeping partner in sight
- Twist lock knob for clamping to rod or pole
- 20-min bubble vial for accurate and quick setup
- Special mirror allows for direct reading of adjustable circular bubble



FGC20ELAZ

### ELEVATOR COMPOSITE TRIPOD

The **FGC20 is a medium duty fiberglass tripod** with positive locking quick clamp style clamps. Adjustable center column with height adjustment range of 20-in (51cm) and metal gear & rack system for smooth continuous motion.

- Double banded extension legs and large positive locking quick clamp for extra stability
- Precision machined aluminum head and leg hinges provides stable mounting base
- Die-cast aluminum shoe with hardened steel replaceable shoe points
- Powder coated castings for durability and wear-resistance
- Includes: heavy-duty poly-webbing shoulder strap

sku	extend	collapse	clamping	head style	wgt
01-FGC20ELAZ-B	93" (2.36m)	48" (1.22m)	Quick Clamp	5/8-11, Flat Head	15lb (6.7kg)



LARGE QUICK CLAMP  
LEVER

01-FGC20ELAZ-B

FGH30ELAZ

### ELEVATOR COMPOSITE TRIPOD

The **FGHD30 elevator tripod is a heavy duty with dual clamp** design for added extra stability - both positive locking quick clamp and wing screw. Tall adjustable center column with height adjustment range up to 44-in (112cm) and metal gear & rack system for smooth continuous motion.

- Double banded extension legs and large positive locking quick clamp for extra stability
- Precision machined aluminum head and leg hinges provide stable mounting base
- Die-cast aluminum shoe with hardened steel replaceable shoe points
- Powder coated castings for durability and wear-resistance
- Includes: heavy-duty poly-webbing shoulder strap

sku	extend	collapse	clamping	head style	wgt
01-FGH30ELAZ-DCB	12' 8" (3.86m)	72" (1.82m)	Dual Clamp	5/8-11, Flat Head	33lb (15kg)



01-FGH30ELAZ-DCB

**RHIVIZ20-B**
**SPECIAL UV-RESISTANT HI-VIZ GREEN**
**SALAMANDER ROBOTIC COMPOSITE TRIPOD**

- Ideal for robotic total stations and laser scanners or construction lasers where accuracy is important
- **Meets ISO standard (12858-2-H)**
- Tongue-groove strut and legs for stability and accurate performance
- Heavy duty dual clamp design adds extra stability - both quick clamp and wing screw
- Double banded extension legs and large positive locking quick clamp add stability
- Ergonomic hand carrying handle
- Large 6-5/8-in (17cm) precision machined flat head with large 2-3/8-in (6cm) center hole for easy set-up over a point
- Large foot pad for solid planting and improved stability on any terrain
- Replaceable shoe points
- Built-in retainer support tabs for adding support system to prevent leg kick out
- Includes heavy-duty poly-webbing shoulder strap, retainer strap, head protective cap, adjustment tool

sku	extended	collapsed	clamping	head style	net wgt	hardware
<b>01-RHIVIZ20-B</b>	70" (180cm)	44.75" (114cm)	Dual Clamp	5/8-11, Flat Head	17.8lb (8.1kg)	Black

**SHIVIZ20-B**
**SPECIAL UV-RESISTANT HI-VIZ GREEN**
**SALAMANDER SURVEYOR COMPOSITE TRIPOD**

- Ideal for both land surveying and precision construction instruments
- Durable all composite legs and struts with powder coated wear-resistant metal hardware
- Double banded extension legs and large positive locking quick clamp
- Precision machined triangular flat head with center hole for easy set-up over a point
- Precision machined aluminum head and leg hinges provide stable mounting base
- Die-cast aluminum shoe with hardened steel replaceable shoe points
- Includes heavy-duty poly-webbing shoulder strap for ease of carrying to the job site

sku	extended	collapsed	clamping	head style	net wgt	hardware
<b>01-SHIVIZ20-B</b>	70" (180cm)	44.75" (114cm)	Quick Clamp	5/8-11, Flat Head	16.6lb (7.5kg)	Black

**VHIVIZ20-B**
**SPECIAL UV-RESISTANT HI-VIZ GREEN**
**SALAMANDER CONTRACTOR COMPOSITE TRIPOD**

- Ideal for optical and laser construction instruments
- Medium weight fiberglass tripod
- Powder coated wear-resistant metal hardware
- Double banded extension legs and large positive locking quick clamp
- Precision machined triangular flat head with 5/8-11 mounting thread
- Die-cast aluminum shoe with hardened steel replaceable shoe points
- Includes heavy-duty poly-webbing shoulder strap for ease of carrying to the job site

sku	extended	collapsed	clamping	head style	net wgt	hardware
<b>01-VHIVIZ20-B</b>	70" (180cm)	44.75" (114cm)	Quick Clamp	5/8-11, Flat Head	16.0lb (7.2kg)	Black

**ALHVZ20**
**SALAMANDER CONTRACTOR ALUMINUM TRIPOD**

- Ideal for optical and laser construction instruments
- Medium weight, heavy gauge aluminum with added stability of double banded legs
- Positive locking quick release clamps
- Precision machined triangular flat head with 5/8-11 mounting thread
- Powder coated wear-resistant metal hardware
- Die-cast aluminum shoe with hardened steel replaceable shoe points
- Includes heavy-duty poly-webbing shoulder strap

sku	extended	collapsed	clamping	head style	net wgt	hardware
<b>01-ALHVZ20</b>	64" (163cm)	40" (102cm)	Quick Clamp	5/8-11, Flat Head	10lb (4.6kg)	Black

Place your company logo and contact on poles. Ask for details.

## HVFG-DC

### SITEMAX™ LARGE HEAD COMPOSITE TRIPOD WITH DUAL-CLAMP

The SiteMax HVFG is the best value heavy duty fiberglass tripod on the market. Heavy duty dual clamp design add extra stability - both quick clamp and wing screw. Large round head is precision machined to add even more stability for your instrument.

- Powder coated wear-resistant metal hardware
- Double banded extension legs and large positive locking quick clamp add stability
- Precision machined 6-in (15.2cm) round flat head with 5/8-11 mounting thread
- Replaceable shoe points
- Ergonomic hand carrying handle
- Includes heavy-duty poly-webbing shoulder strap, head protective cap, adjustment tool

sku	extended	collapsed	clamping	head style	net wgt	hardware
<b>01-HVFG20-DCB</b>	72" (183cm)	47" (119cm)	Dual Clamp	5/8-11, Flat Head	18lb (8.2kg)	Black

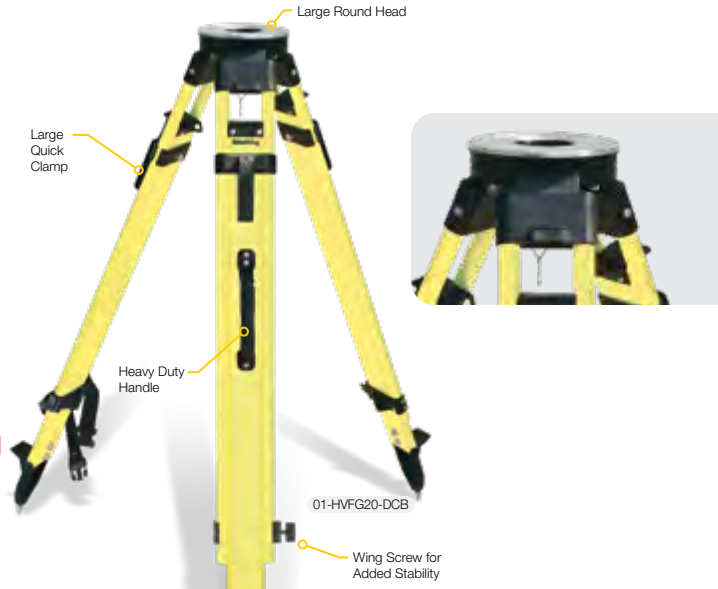

# SitePro™

## COMPOSITE & WOOD TRIPODS



## SFBR20 SERIES

NEW!

### SURVEYOR FIBERGLASS TRIPODS

The New SFBR is the best value heavy duty fiberglass tripod. Heavy duty clamping designs add extra stability - offering two models to fit your needs.

- Flat precision machined tripod head to add even more stability for your instrument
- Powder coated wear-resistant metal hardware
- Double banded extension legs and large newly designed positive locking quick clamp add stability
- Replaceable shoe points
- Ergonomic hand carrying handle
- Includes heavy-duty poly-webbing shoulder strap, head protective cap, adjustment tool

sku	extended	collapsed	clamping	head style	net wgt	hardware
<b>01-SFBR20-DCB</b>	71" (181cm)	45" (114cm)	Dual Clamp	5/8-11, 6-in Flat Head	16.1lb (7.3kg)	Black
<b>01-SFBR20-B</b>	71" (181cm)	45" (114cm)	Quick Clamp	5/8-11, Std Flat Head	16.1lb (7.3kg)	Black



## WDW20

### WOOD TRIPOD, WING SCREW

The WDW tripod is made of high quality hardwood with wide-frame extension legs and 1-in diameter dowels. Designed to absorb and dampen vibration which adds stability for your instrument.

- Large precision machined aluminum head
- Wing screw style clamp with die cast aluminum hardware for maximum stability
- Wear-resistant with treated finish and powder coated metal hardware
- Aluminum shoe with hardened steel replaceable shoe points
- Includes heavy-duty poly-webbing shoulder strap, head protective cap, adjustment tool

sku	extended	collapsed	clamping	head style	net wgt	hardware
<b>01-WDW20HV-O</b>	72" (183cm)	42" (107cm)	Wing Screw	5/8-11, Flat Head	16lb (7.2kg)	Orange



Place your company logo and contact on poles. Ask for details.



### ALQR20-DC

## HEAVY-DUTY ALUMINUM TRIPOD, DUAL CLAMP SYSTEM

The ALQR Series tripods are made of medium weight, heavy gauge aluminum with added stability of double banded legs.

- Positive locking quick release clamps
- Precision machined triangular flat head with 5/8-11 mounting thread
- Powder coated wear-resistant metal hardware
- Replaceable shoe points
- Includes heavy-duty poly-webbing shoulder strap

sku	extended	collapsed	clamping	head style	net wgt	hardware
<b>01-ALQR20-DCB</b>	64" (163cm)	40" (102cm)	Dual Clamp	5/8-11, Flat Head	10lb (4.6kg)	Black



01-ALQR20-DCB

### ALQR20

## ALUMINUM TRIPOD WITH QUICK RELEASE

The ALQR Series tripods are made of medium weight, heavy gauge aluminum with added stability of double banded legs.

- Positive locking quick release clamps
- Precision machined triangular flat head with 5/8-11 mounting thread
- Powder coated wear-resistant metal hardware
- Replaceable shoe points
- Includes heavy-duty poly-webbing shoulder strap

sku	extended	collapsed	clamping	head style	net wgt	hardware
<b>01-ALQR20-B</b>	64" (163cm)	40" (102cm)	Quick Clamp	5/8-11, Flat Head	10lb (4.6kg)	Black
<b>01-ALQR20-O</b>	64" (163cm)	40" (102cm)	Quick Clamp	5/8-11, Flat Head	10lb (4.6kg)	Orange



01-ALQR20-B

### ALQR40

## DOMED-HEAD ALUMINUM TRIPOD

The ALQR Series tripods are made of medium weight, heavy gauge aluminum with added stability of double banded legs.

- Circular dome head for fast setup with compensated instruments and lasers
- Positive locking quick release clamps
- Powder coated wear-resistant metal hardware
- Replaceable shoe points
- Includes: heavy-duty poly-webbing shoulder strap

sku	extended	collapsed	clamping	head style	net wgt	hardware
<b>01-ALQR40-B</b>	64" (163cm)	40" (102cm)	Quick Clamp	5/8-11, Dome Head	10lb (4.6kg)	Black



01-ALQR40-B

## EASY COLLAPSE & CARRY

Carrying your tripod to and from the jobsite with other gear or tools can be cumbersome. The heavy duty poly-webbed shoulder strap makes it easier.

Strap is **included with all SitePro Tripods** and has built-in webbed belt with locking clip to secure legs of tripod.





### ALW20

## ALUMINUM TRIPOD WITH WING SCREW

The ALW20 is a heavy duty, aluminum tripod with wing screw clamps.

- Aluminum hinge, clamp and shoe castings
- Precision machined triangular flat head with 5/8-11 mounting thread
- Replaceable shoe points
- Powder coated castings for durability and wear-resistance
- Includes heavy-duty poly-webbing shoulder strap

sku	extended	collapsed	clamping	head style	net wgt	hardware
01-ALW20-B	65" (165cm)	42" (107cm)	Wing Screw	5/8-11, Flat Head	10lb (4.6kg)	Black



### ALW10

## ALUMINUM MINI-TRIPOD WITH WING SCREW

The ALW10 tripod has a small footprint, yet heavy duty and sturdy. Features standard head with wing screw clamps.

- Aluminum hinge, clamp and shoe castings
- Precision machined triangular flat head with 5/8-11 mounting thread
- Replaceable shoe points
- Powder coated castings for durability and wear-resistance
- Includes carrying strap and adjustment tool

sku	extended	collapsed	clamping	head style	net wgt	hardware
01-ALW10-B	28.5" (73cm)	22" (56cm)	Wing Screw	5/8-11, Flat Head	6.4lb (2.9kg)	Black

### ALC20

## ALUMINUM TRIPOD WITH QUICK CLAMP

The ALC is a lightweight, aluminum contractors' tripod with positive locking quick clamp style clamps and individually tightened hinge screws.

- Aluminum hinge, clamp and shoe castings with replaceable shoe points
- Powder coated castings for durability and wear-resistance
- Includes heavy-duty poly-webbing shoulder strap

sku	extended	collapsed	clamping	head style	net wgt	hardware
01-ALC20-B	65" (165cm)	39" (99cm)	Quick Clamp	5/8-11, Flat Head	9.0lb (4.1kg)	Black

Note: 01-ALC20-B is the standard tripod included with SitePro instrument kits.



### 01-TLS

## TRIPOD RETAINER STRAP

- Use with tripods with clamp lock holder on legs
- Fixes the legs in place to maintain stability while you work
- Use with SitePro model RHIVIZ20 and HVFG-DC



### 01-TFG2

## TRIPOD FLOOR GUIDE

- Ideal when setting up tripod on slick surfaces and concrete floors. Makes setting up over a point faster
- Heavy-duty aluminum arms with slots to extend and stabilize tripod legs to 25.4-in (65cm) from center; additional slots to extend 14-in (35.6cm) from center
- Tripod mounts to the legs which have slots for points and rubber straps
- Weight: 1.0lb (0.45kg)

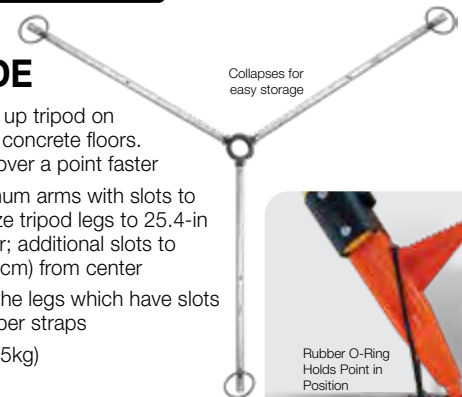



### SPR-SERIES SURVEYOR'S FIBERGLASS GRADE ROD

Our most popular rods designed for surveyors, the SitePro SPR-Series leveling rods are constructed of durable, rigid fiberglass with reinforced ribs for strength and stability. Lightweight, telescoping rectangular-oval shaped sections make the SPR-Series leveling rod easier to grip and allows for widened easy-to-read scales. Graduated scales are glare-resistant with formulated coating that protects the scales from wear.

- Reliable, long-lasting spring-loaded round buttons provide tight, secure, locking of the sections, and designed to resist jamming from debris
- Special backside measuring scale allows users to read overall height measurements at eye level
- 1/4-20 female adapter in top section for mounting prism
- Non-conductive fiberglass is water-proof and corrosion-resistant
- Glare resistant, easy-to-read graduations and a special measuring scale on the backside, suitable for many clearance and height measurements
- Sections are removable for easy cleaning
- Includes carrying case



### MOUNTING TIP FOR MINI PRISM

Top section of leveling rod has built-in 1/4-20 female thread, ideal for mounting a mini prism



### RELIABLE, SPRING LOADED BUTTONS

Section buttons (# Z11-SPRBUTTON) are round to provide tight, secure, locking of the sections, and designed to resist jamming from debris.

sku	length	graduations	sections	collapsed	wgt
11-SPR17-T	17-ft	10ths/100ths	5	48-in (122cm)	5.00lb (2.3kg)
11-SPR17-C	17-ft	Inches/8ths	5	48-in (122cm)	5.00lb (2.3kg)
11-SPR25-T	25-ft	10ths/100ths	6	58.5-in (149cm)	6.00lb (2.3kg)
11-SPR25-C	25-ft	Inches/8ths	6	58.5-in (149cm)	6.00lb (2.3kg)
11-SPR07-M	7.6m	Metric "E",mm	6	58.5-in (149cm)	6.00lb (2.3kg)



SPR-Series include carrying case with carrying strap





### SCR-SERIES

## CONSTRUCTION FIBERGLASS GRADE ROD

The SitePro SCR-Series leveling rods are constructed of durable corrosion-resistant and non-conductive fiberglass. Lightweight, telescoping rectangular shaped sections with rounded back corners make the SCR-Series leveling rod easier to grip.

Features stand-off ribs on front corners to protect the large, easy-to-read graduated scale from wear. Scales are glare-resistant with formulated coating that protects the scales from wear.

- Reliable, long-lasting spring-loaded Delrin® buttons (#Z11-SCRBUTTON) securely lock sections together, and designed to resist jamming from debris
- Special backside measuring scale allows users to read overall height measurements at eye level
- Rectangular shape allows for laser detector clamp to mount to any section of the leveling rod
- Non-conductive fiberglass is water-proof and corrosion-resistant
- Sections are removable for easy cleaning

sku	length	graduations	sections	collapsed	wgt
11-SCR13-C	13-ft	8ths	4	58-in (148cm)	4.5lb (2.0kg)
11-SCR13-T	13-ft	100ths	4	58-in (148cm)	4.5lb (2.0kg)
11-SCR16-C	16-ft	8ths	5	57-in (145cm)	6.2lb (2.8kg)
11-SCR16-T	16-ft	100ths	5	57-in (145cm)	6.2lb (2.8kg)
11-SCR25-C	25-ft	8ths	6	63.5-in (161cm)	10lb (4.5kg)
11-SCR25-T	25-ft	100ths	6	63.5-in (161cm)	10lb (4.5kg)
11-SCR05-M	5m	Metric 'E'	5	57-in (145cm)	6.2lb (2.8kg)

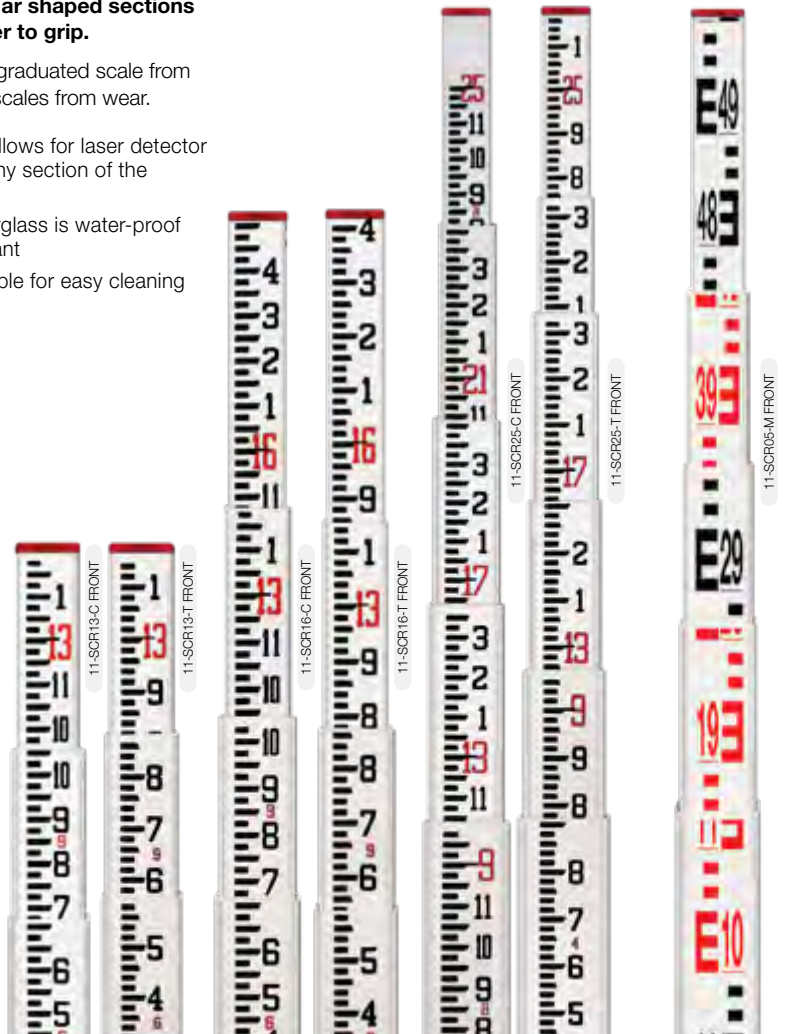

## CONSTRUCTED TOUGH

DURABLE, RIGID FIBERGLASS WITH REINFORCED DESIGN FOR STRENGTH & STABILITY



### MOUNTING TIP FOR MINI PRISM

Top section of leveling rod has built-in 1/4-20 female thread, ideal for mounting a mini prism.



### GRADUATED IMPRINTED BACKSIDE

Special backside measuring scale allows users to read overall height measurements at eye level



SCR-Series include carrying case with carrying strap





### 11-8 SERIES

## ALUMINUM LEVELING RODS

The SitePro telescoping aluminum leveling rod are constructed with durable, lightweight aluminum alloy that allows smooth extension and prevents unnecessary clattering.

The 11-8 series are imprinted with weather and corrosion-resistant inks. The telescoping sections are injection molded section joints and capped with secure high strength buttons.

- Lightweight and durable telescoping aluminum leveling rods
- Heavy duty aluminum wall thickness
- Easy-to-read graduations with measuring scale on the backside for direct reading at eye level
- Three different unit of measure are available, see graduations: 8ths, 100ths, and Metric
- Includes leveling bubble vial attachment and carrying case



### SNAP-IN PUSH BUTTON

High strength push-buttons with injection molded section joints for secure locking of telescopic sections.



### ATTACHABLE ROD LEVEL

Bubble Vial Attachment easily clips into slot for quick leveling of aluminum rods.

### INCLUDES CARRYING CASE

All SitePro 11-8 series aluminum rods include carrying case with accessory pouch and shoulder strap.

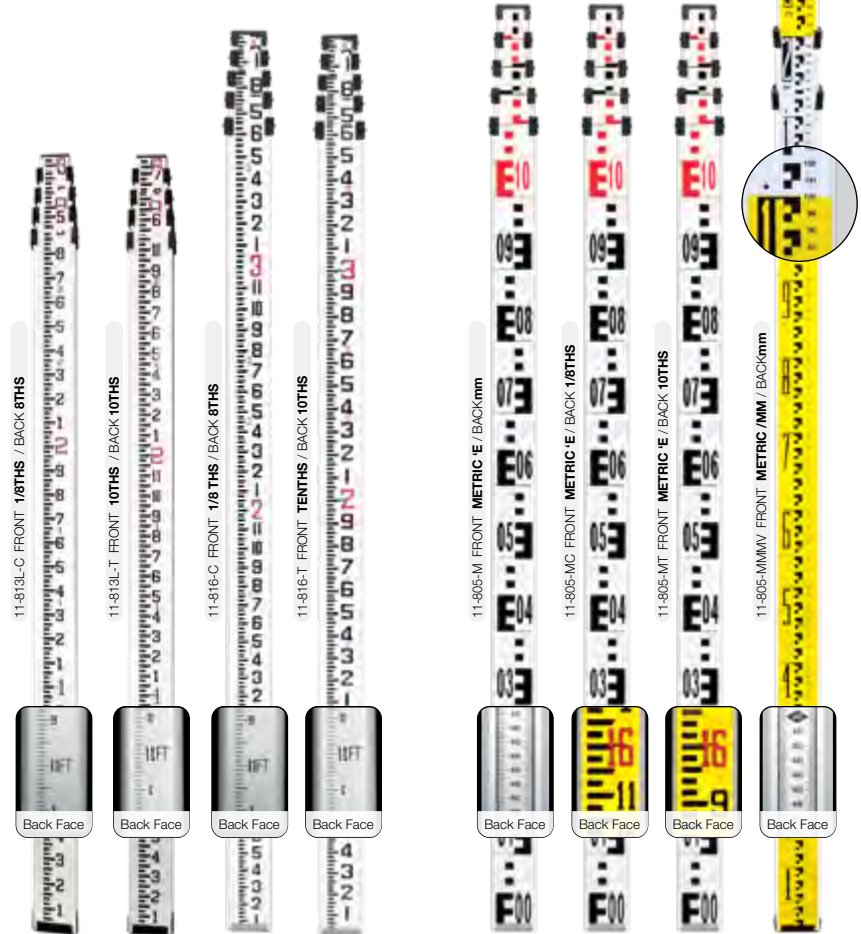

sku	length	graduations - front face	graduations - back face	sections	collapsed	wgt
<b>11-813L-C</b> <small>NEW!</small>	13-ft	Feet Inches/8ths	Feet Inches/8ths	5	38.6-in (98cm)	3.15lb (1.43kg)
<b>11-813L-T</b> <small>NEW!</small>	13-ft	Feet 10ths/100ths	Feet 10ths/100ths	5	38.6-in (98cm)	3.15 lb (1.43kg)
<b>11-816-C</b>	16-ft	Feet Inches	Feet Inches/8ths	5	48-in (123cm)	3.5lb (1.6kg)
<b>11-816-T</b>	16-ft	Feet 10ths/100ths	Feet 10ths/100ths	5	48-in (123cm)	3.5lb (1.6kg)
<b>11-805-BM</b> <small>Not Shown</small>	5m	Barcode Used w/ 25-SDL32 (Pg 11)	Metric E	5	48-in (122cm)	3.5 lb (1.6kg)
<b>11-805-M</b>	5m	Metric "E"	Metric mm	5	48-in (122cm)	3.5lb (1.6kg)
<b>11-805-MC</b>	5m 16-ft	Metric 'E' Feet Inches	Feet Inches/8ths	5	48-in (122cm)	3.5lb (1.6kg)
<b>11-805-MT</b>	5m 16-ft	Metric 'E' Feet Tenths	Feet 10ths/100ths	5	48-in (122cm)	3.5lb (1.6kg)
<b>11-805-MMMV</b>	5m	Metric, 1/2cm, mm	Metric 1/2cm, mm	5	122cm (48-in)	1.6kg (3.5lb)

Note: 11-813L is the standard leveling rod included with SitePro instrument kits.

### 11-TURLT

## 5-IN ROD TURNING PLATES

This turning plate is used to improve the accuracy of level runs in soft terrain.

- Leveling plates (or Turtles as they are commonly known) are powder painted heavy cast steel for durability and longevity
- Handle with ground points
- Dome is 1.2-in (3.0cm) half ball; Diameter: 5-in (12.7cm). Height of foot to top of half ball: 2.75-in (7cm); Weight: 6.6lb (3.0kg)
- **Set of Two (2) turning plates**



### 11-850

## SNAP-ON ROD LEVEL

- Fits most aluminum leveling rods, including **11-8 Series**
- Built-in 30-minute vial





### APPLICATIONS

- Land surveying
- General construction
- Law enforcement
- Road construction
- Utilities
- Real estate appraisals



## PS 401M 1M PROFESSIONAL MEASURING WHEEL, METRIC

PROFESSIONAL **3** YEAR WARRANTY

All-steel construction with accuracy 1 cm measuring and belt-driven counter. Professionals can count on the durable design and accurate, reliable measuring.

- 5-digit belt-driven counter records up to 9,999.9 meters with convenient rest knob
- 1m circumference spoke wheel and wide rubber tire makes it easier to measure accurately on rough terrain & uneven ground
- Wheel brake prevents slipping and allows for easy transport without losing measurement
- Built-in wheel stand keeps wheel upright
- Easy-grip handle folds for compact storage when not in use

sku	wheel dia.	circum.	units	wgt	extended height	collapse height
31-PS401M	0.31m	1m	m	4.3lb (1.95kg)	45.5" (116cm)	21.5" (55cm)



### APPLICATIONS

- Land Surveying
- General construction
- Law enforcement
- Road construction
- Utilities
- Landscaping



## PS 301 SPOKED 3' PROFESSIONAL MEASURING WHEEL

PROFESSIONAL **3** YEAR WARRANTY

All-steel construction with an 11-1/2 inches (3-ft circumference) steel-spoked wheel. **Most popular wheel in performance, durability, and value.**

- 5-digit ratchet-style mechanical counter records up to 99,999 feet with rest knob
- Steel-spoked wheel, wide rubber tire registers single feet click (3-ft per revolution)
- Built-in wheel stand keeps wheel upright
- Wheel brake prevents wheel from slipping and allows for easy transport without losing existing measurement
- Easy-grip handle quickly collapses for compact storage when not in use

sku	wheel dia.	circum.	units	wgt	extended height	collapse height
31-PS301	11-1/2 in	3 ft.	ft	5.3lb (2.4kg)	45.5" (116cm)	26.5" (67cm)



### APPLICATIONS

- Landscaping
- General construction
- Law enforcement
- Road construction
- Real estate appraisals
- Home remodeling



## RS 312/RS 312M 12-1/2"/0.318M MEASURING WHEEL

CONTRACTOR **1** YEAR WARRANTY

Aluminum three-spoke wheel with precision molded wide rubber tire. Affordable, easy to use measuring wheel and more accurate on rough terrain than other wheels on the market.

- 5-digit, easy-read counter
- 3-section aluminum telescopic handle with lever locks collapses for easy storage
- Robust, industry-proven meter housing is durable, heavy duty poly cast
- Measures in both directions
- Reset switch to set counter to <00000>
- Comfortable, ergonomic pistol grip handle
- Fold-away kick stand keeps wheel upright when not in use

sku	wheel dia.	circum.	units	wgt	extended height	collapse height
31-RS312	12-1/2 in	3 ft.	ft/in	3.2lb (1.5kg)	44.5" (113cm)	26" (66cm)
31-RS312M	0.318m	1m	m/dm	3.2lb (1.5kg)	44.5" (113cm)	26" (66cm)



### APPLICATIONS

- Home remodeling
- Interior design
- Real estate appraisals
- General construction



## RS 104 COMPACT 4" MEASURING WHEEL, FT/IN

CONTRACTOR **1** YEAR WARRANTY

Compact measuring wheel is lightweight and durable. Wide, precision molded tire provides accurate measurements on any smooth, hard surface from interior floors to sidewalks.

- 5-digit, easy-read counter measures 9,999 feet, 11 inches
- Heavy-duty 1-ft circumference poly cast six-spoke plastic wheel with rubber tread
- Robust, industry-proven meter housing is durable, heavy duty poly cast
- Measures in both directions with reset switch to set counter to <00000>
- Easy grip handle with 3-section aluminum telescopic handle with lever locks collapses for easy storage

sku	wheel dia.	circum.	units	wgt	extended height	collapse height
31-RS104	4 in	1 ft.	ft/in	1lb (0.45kg)	38.5" (98cm)	18.3" (46.5cm)



SitePro PS-Series measuring wheels are guaranteed with a three (3) year limited warranty. RS-Series measuring wheels are guaranteed with a one (1) year limited warranty. Unless otherwise specified, accessory items include a 90-day limited warranty.



### 34-SERIES

#### FIBERGLASS TAPES

- Durable with non-woven pvc-coated fiberglass, waterproof
- Dual-sided graduations
- Easy to rewind with fast reel design (3:1 gear ratio), with folding crank handle
- Tape width is 1/2-inch with various graduations available



34-Y3001

sku	length	unit of measure
<b>34-Y1001</b>	100-ft	10ths/100ths
<b>34-Y2001</b>	200-ft	10ths/100ths
<b>34-Y3001</b>	300-ft	10ths/100ths
<b>34-Y1008M</b>	100-ft /30m	<b>Side 1:</b> Inch/8ths; <b>Side 2:</b> Meter/cm/mm
<b>34-Y1001M</b>	100-ft /30m	<b>Side 1:</b> 10ths/100ths; <b>Side 2:</b> Meter/cm/mm
<b>34-Y1658M</b>	165-ft /50m	<b>Side 1:</b> Inch/8ths; <b>Side 2:</b> Meter/cm/mm
<b>34-Y1651M</b>	165-ft /50m	<b>Side 1:</b> 10ths/100ths; <b>Side 2:</b> Meter/cm/mm

sku	length	unit of measure
<b>34-Y1008</b>	100-ft	Inch/8ths
<b>34-Y2008</b>	200-ft	Inch/8ths
<b>34-Y3008</b>	300-ft	Inch/8ths
<b>34-Y3008M</b>	300' /100m	<b>Side 1:</b> Inch/8ths; <b>Side 2:</b> Meter/cm/mm
<b>34-Y30M</b>	30M	Meter/cm/mm
<b>34-Y50M</b>	50M	Meter/cm/mm
<b>34-Y100M</b>	100M	Meter/cm/mm

90 day warranty.

### 32-SERIES

#### STEEL TAPES

- Accurate and durable high tempered steel tapes with temperature stability for superior performance.
- Nylon coated wear-resistant graduated tape withstands the extreme conditions
- Dual-sided graduations
- Easy to rewind with fast reel design (3:1 gear ratio), with folding crank handle
- Tape width is 1/2-inch with various graduations available



32-30080

B End Type

sku	length	end type*	unit of measure
<b>32-10010B</b>	100-ft	B	10ths/100ths
<b>32-20010B</b>	200-ft	B	10ths/100ths
<b>32-30010B</b>	300-ft	B	10ths/100ths
<b>32-10080B</b>	100-ft	B	Inch/8ths
<b>32-20080B</b>	200-ft	B	Inch/8ths

sku	length	end type*	unit of measure
<b>32-30080B</b>	300-ft	B	Inch/8ths
<b>32-30MA</b>	30m	A	Meter/cm/mm
<b>32-50MA</b>	50m	A	Meter/cm/mm
<b>32-100MA</b>	100m	A	Meter/cm/mm

90 day warranty.

### 35-SERIES

#### DEPTH GAUGE TAPES

Lightweight fiberglass tapes are rugged and versatile, ideal for measuring in water, mud, and rough terrain.



sku	length	units of measure
<b>35-2588</b>	25-ft	Feet/Inches
<b>35-5088</b>	50-ft	Feet/Inches
<b>35-10088</b>	100-ft	Feet/Inches
<b>35-20088</b>	200-ft	Feet/Inches
<b>35-30MM</b>	30M	Metric/mm
<b>35-50MM</b>	50M	Metric/mm



### ST101

## SMART-TRAK™ MAGNETIC LOCATOR

The Smart-TRAK is the smart choice for locating manholes, steel covers, septic systems, corner survey markers, cast iron pipes, iron valves, and re-bar. The ST100 series feature one-handed operation with pinpoint accuracy and large visual display.

- Precision-crafted superior ergonomics and balanced design for one-handed operation
- Large LCD screen for visual search results 0-99 numeric indicator with signal strength bar graph and battery level indicator
- High-grade waterproof speaker is water resistant and dust proof to ensure years of dependable operation
- Robust co-molded housing is water resistant and dust proof to ensure years of dependable operation
- Waterproof tube (IP67) and tip for locating even in the toughest environments and weather conditions



### ST102

## SMART-TRAK™ MAGNETIC LOCATOR

The ST102 features patent pending **Smart-Search Technology™** that provides pinpoint accuracy around fences or other large metal objects.

- Precision-crafted superior ergonomics and balanced design for one-handed operation
- Large LCD screen for visual search results 0-99 numeric indicator with signal strength bar graph, North/South polarity indicator, and battery level indicator
- Four (4) modes of operation: Standard, Erase, Smart+, Smart-
- High-grade waterproof speaker is water resistant and dust proof to ensure years of dependable operation
- Robust co-molded housing is water resistant and dust proof to ensure years of dependable operation
- Waterproof tube (IP67) and tip for locating even in the toughest environments and weather conditions

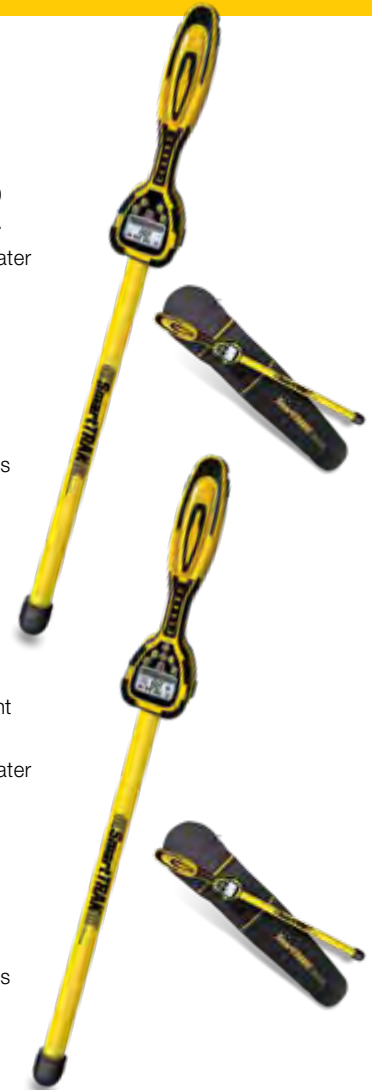

SURVEY MARKERS

10-ft (3m)

MANHOLE COVERS

10-ft (3m)

CAST IRON PIPE (4")

10-ft (3m)

SEPTIC TANK HANDLES

8-ft (1.8m)

MAG NAILS

1-ft to 2.7-ft  
(30cm to 82cm)

REBAR

9-ft (2.7m)



SmartTrak is proudly made in U.S.A.

	59-ST102	59-ST101
<b>Audio Output:</b>	10Hz frequency tone, increases with magnetic field strength	
<b>Visual Output:</b>	LCD - Numeric 0-99, signal strength bar graph	
<b>Gain (Sensitivity):</b>	6 settings	
<b>Smart-Search</b>	Yes	No
<b>Volume:</b>	4 settings	
<b>Modes:</b>	Standard, Erase, Smart +, Smart -	Standard
<b>Power:</b>	Six AA alkaline batteries- 50 hours (intermittent operation)	
<b>Operating Temp:</b>	-13° F to 140° F (-25° C to 60° C)	
<b>Weight:</b>	2.5lb (1.13kg) with batteries	
<b>Length:</b>	42-3/4 in (108.6cm)	
<b>Environment:</b>	IP54 – plastic housing; IP67 – sensor tube to below plastic housing	
<b>Includes:</b>	Carrying case, batteries, user guide	

SmartTrak locators are guaranteed with a seven (7) year limited warranty. Unless otherwise specified, accessory items include a 90-day limited warranty.

## THE SMART CHOICE FOR LOCATING FERROUS METALS

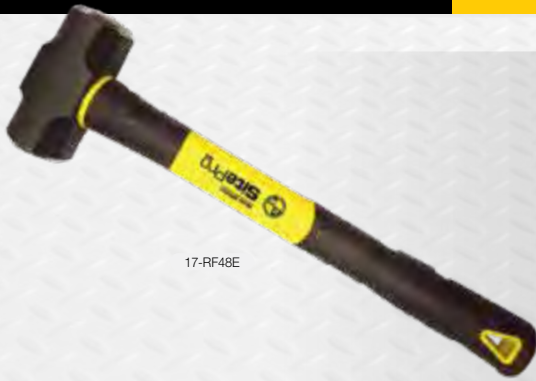

17-RF48E

## 17-RF48E, 17-RF64E

### 48OZ / 64OZ ENGINEER'S HAMMER

- Made from forged steel head which is hardened and tempered
- Dual machine finished faces that are beveled and fully polished
- Designed for striking spikes and hardened nails, cold chisels, brick chisels, punches, star drills
- Textured yellow fiberglass handle which allows for heavier blows in an environment where there is limited swing
- Ribbed grip to help prevent slipping

## 17-EWB3-4LB

### 4LB CLUB/DRILLING HAMMER

Made from forged steel head which is hardened and tempered. Ideal for use with chisels, punches, star drills and hardened nails.

- 10-inch Handle & Shock Reduction Grip
- Permits heavy blows with limited swing
- Head and handle are forged in one piece and have a black UV coating
- Both faces are fully polished



## 17-FP18FY

HI-VIS TIP

### 18" FROST PIN

Ideal for breaking up hardened, dried earth as well as frozen ground.

- Made of 1" diameter high grade tool steel
- 2" button top and a hardened diamond point
- Weighs 4.0lb (1.8kg)

## 17-GAD18

HI-VIS TIP

### 18" GAD

Ideally used to break, chip, chisel and pry rocks apart.

- Size: 3/4" x 1-1/2"
- Made of high-grade tool steel
- Hardened-steel tip
- Weighs 5.3lb (2.4kg)



## 17-MCP32-FH

HI-VIS TIP

### MANHOLE COVER PICK

Ideal for lifting drain grate and manhole cover safely while protecting your hands from injury as well as back and other injuries.

- Made of 5/8" hex high grade tool steel
- Harden steel flat head tip
- Length: 32"



### 17-AX8901

## 4.5LB WOOD SPLITTING MAUL

- Ideal for splitting wood or driving wedges and stakes
- Fully forged and hardened steel head
- 3-1/2" geometric blade optimizes penetration to blast tough logs apart
- Forged, heat-treated steel is finished with a rust-resistant coating
- Durable straight-grained Hickory handle
- Hawk length: 8"; Overall length: 36"
- Overall weight: 6.5lb (2.9kg)

### 17-AX3902

## 1.75LB AXE WITH HICKORY HANDLE

- Compact axe intended for bringing down or cutting up small to medium sized trees
- Fully forged and hardened steel head
- 4-3/8" geometric blade optimizes penetration
- 13.5" curved shaft handle is made of durable straight-grained Hickory
- Hawk length: 6-3/8" (16.2cm)
- Head weight: 1.75lb (0.79kg)
- Overall length: 15.3" (38.9cm)
- Weighs: 2.4lb (1.1kg)



### COLO SERIES

## HEAVY DUTY MACHETES

SIZES **18" 22" 24" 28"**

The COLO-Series machetes are heavy duty tempered steel blade for strength and longevity and world's best selling machete with lifetime guarantee<sup>1</sup>.

- Colombian made
- 5" (127mm) ergonomic handle is made of durable engineered wood for better gripping power and longevity
- 2.5mm thick, hot roll tempered high carbon steel blade for strength (49 HRC)
- Sharpenable blade extends through the riveted handle for durability
- Blade lengths: 18", 22", 24", and 28"

WORLD'S BEST SELLING MACHETE WITH LIFETIME GUARANTEE



COLO22-W  
Shown in  
Packaging

sku	blade length	handle type	thickness	HRC rating	wgt
<b>17-COLO18-W*</b>	18" (45.7cm)	Engineered Wood	2.5mm	49 (+/- 1)	19oz (580g)
<b>17-COLO22-W*</b>	22-1/8" (56.2cm)	Engineered Wood	2.5mm	49 (+/- 1)	20.5oz (580g)

sku	blade length	handle type	thickness	HRC rating	wgt
<b>17-COLO24-W*</b>	24-1/4" (61.6cm)	Engineered Wood	2.5mm	49 (+/- 1)	22.0oz (623g)
<b>17-COLO28-W</b>	27-15/16" (71cm)	Engineered Wood	2.5mm	49 (+/- 1)	22.8oz (646g)

\*Packaged with sheath available. Call for details.

<sup>1</sup> Guaranteed not to break with normal use. Find more details at [dwsitepro.com](http://dwsitepro.com)

### CROC SERIES

## MARTINDALE® PRO MACHETES

SIZES **18" 22" 24" 28"**

The CROC-Series Machetes are made from British steel that is hand rolled. Each knife is individually made by a hand rolling process from high quality British carbon steel, which makes the blades strong and durable.

- 2.25mm thick carbon steel blade is strong and durable (45-52 HRC)
- 5" (127mm) handle is available in solid beech wood or durable plastic
- Turn-back grip handle
- Sharpenable blade extends through the riveted handle for durability
- Blade lengths: 22", 24", and 28"

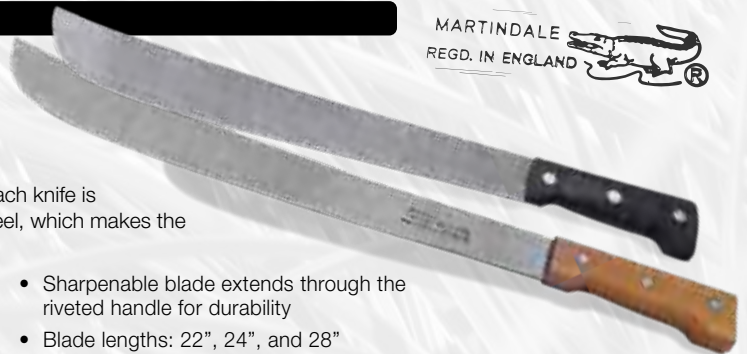

sku	blade length	handle type	thickness	HRC rating	wgt
<b>17-CROC22-P</b>	21-3/4" (55.3cm)	Plastic	2.25mm	45-52	18.4oz (522g)
<b>17-CROC22-W</b>	21-3/4" (55.3cm)	Wood	2.25mm	45-52	20oz (567g)
<b>17-CROC24-P</b>	23-3/4" (60.3cm)	Plastic	2.25mm	45-52	20oz (567g)

sku	blade length	handle type	thickness	HRC rating	wgt
<b>17-CROC24-W</b>	23-3/4" (60.3cm)	Wood	2.25mm	45-52	21.8oz (618g)
<b>17-CROC28-W</b>	27-1/2" (69.9cm)	Wood	2.25mm	45-52	22.4oz (635g)

Each Masterpack contains 36 machetes



### MACHETE SHEATHS

Leather sheath keeps your machete safe guarded and handy, protects machete while carrying on your side or during transport. Heavy duty formed leather is side-stitched with durable nylon thread and then riveted at strain points. Built for quality, strength, and longevity.

- Made of heavy duty top grain leather for durability and maximum life
- Double side-stitched and riveted at strain points
- Durable, reinforced 1-1/2-in wide belt loop fits up to 3-in belt
- Available for: 18-in, 22-in, 24-in, and 28-in machete

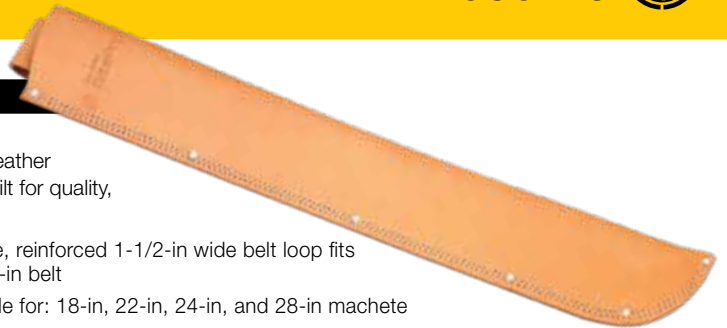

sku	designed for	actual length	fits blade width	wgt
<b>17-LS18</b>	18-in machete	17-1/2"	2-1/2"	0.45lb (204g)
<b>17-LS22</b>	22-in machete	21-1/2"	2-1/2"	0.52lb (235g)

sku	designed for	actual length	fits blade width	wgt
<b>17-LS24</b>	24-in machete	23-1/2"	2-1/2"	0.61lb (276g)
<b>17-LS28</b>	28-in machete	27-1/2"	2-1/2"	0.73lb (331g)

### 1016/2432

### PLUMB BOB SHEATHS

- Keeps your plumb bob handy at your side
- Made of top grain leather for durability and maximum life
- Tapered pocket with snap-button strap fits and secures plumb bob
- Riveted and stitched in heavy duty nylon thread for extra durability
- Slits to fit 2-in belt insertion



sku	designed for
<b>15-1016</b>	16 to 18 ounce plumb bob
<b>15-2432</b>	24 ounce plumb bob

### 51-10218G

### SHEATH FOR GAMMON REEL & PLUMB BOB

Heavy-duty leather scabbard with stitched and riveted pockets provides snug and convenient pockets with cut-out hole on front for easy access.

- Holds 16-18oz plumb bob and Gammon Reel® or tape
- Riveted and stitched in heavy duty nylon thread for extra strength and durability
- Snap button straps secure plumb bob and Gammon Reel in pockets
- Slits for up to 3-in belt insertion



\*Plumb bob and Gammon Reel not included

Gammon Reel® is a registered trademark of Dave White's SitePro

### 17-406

### LEATHER QUIVER FOR MARKING PINS

Leather quiver keeps your survey marking pins handy at your side. Heavy duty formed leather is side-stitched with durable nylon thread and then riveted at strain points. Built for quality, strength, and maximum life.

- Holds up to twelve (12) 14-inch marking pins
- Side-stitched and riveted at strain points, reinforced bottom
- Durable, reinforced 1-1/2-inch wide belt loop fits up to 3-in belt



### 51-10109

### PRO CONTRACTOR'S TOOL POUCH

- Made of top grain saddle leather
- Nine (9) pouches stores: field book, 16oz. plumb bob, marking pins, folding rule, scribe, survey tacks and nails, and pencils.
- Riveted and stitched in heavy duty nylon thread for extra strength and durability
- Tunnel loop saddle fits up to 2-1/2-in belt
- Tapered pocket with snap-button strap secures plumb bob
- Easy access front pocket snap-lid for tacks or nails



### 51-10107

### 7-POCKET SURVEYOR'S TOOL POUCH

Surveyor's tool pouch is made of top grain saddle leather and features seven (7) pockets. Stores field book, plumb bob marking pins, folding rule, scribe, survey tacks and nails, and pencils.

- Riveted and stitched in heavy duty nylon thread for extra strength and durability
- Tunnel loop saddle fits up to 2-1/2-in belt
- Tapered pocket with snap-button strap secures up to 16oz plumb bob
- Easy access front pocket snap-lid for tacks or nails



\*Accessories shown in pouch are not included



## RS-SERIES CUSTOM-FIT SUNGLASSES



LENS | **POLARIZED** | ANSI Z87.1+2010

- Sleek and contemporary with comfort fit
- Soft, pliable TPR material on tips and pads
- Adjustable saddle nose pads for a comfort-fit
- Polycarbonate lenses prevent scratching
- Tapered lens to eliminate refraction

sku	lens type	frame color
24-RS21BP	Polarized	Black

## CN-SERIES 3-POINT FIT SUNGLASSES



LENS | **POLARIZED** | ANSI Z87.1+2010

- Comfortable, stylish design
- Soft, pliable TPR material on tips and pads
- Frames are conveniently lightweight with durable, comfortable straight temple design
- Polycarbonate lenses prevent scratching

sku	lens type	frame color
24-CN21CP	Polarized	Camouflage

## 21-TSRC-G RAIN COVER FOR TOTAL STATION

SIZE | **ONE SIZE FITS MOST**

- Designed for Robotic Total Stations
- Water proof material keeps your instrument dry
- Extended scope hood can be quickly and easily positioned over the scope of instrument
- Clear poly panel on back side to view lcd display
- Dimensions: 9" x 9" x 14" (230 x 230 x 340mm)



## 24-MECCOOL COOLIE™ COOLING TOWEL

SIZE | **ONE SIZE FITS MOST**

- Advanced PVA cooling technology
- Feels significantly cooler than ambient air
- Activates fast and easy - run under cold water for one minute
- Wear for hours or for quick relief
- Simply re-wet to reactivate
- Machine washable
- Size: 12 x 36" (30 x 90cm)

**Cooling Technology** Non-toxic, chemical-free material is super evaporative and feels significantly cooler than ambient air when activated



## SNC5500 / SNC5600 SAFETY NECK SHADE FOR HARD HATS

SIZE | **ONE SIZE FITS MOST**

- One size fits most hard hats
- Elastic band to secure onto hat
- Two colors available
- 3/4-in (19mm) grey reflective stripes with contrast color binding

sku	sizes available	color	reflective stripping
23-SNC5500	One Size Fits All	Flo-Lime	3/4-in (19mm) reflective strip with orange contrast
23-SNC5600	One Size Fits All	Flo-Orange	3/4-in (19mm) reflective strip with yellow contrast







**Lower inside zippered pockets with load-bearing strap** for notebook or iPad®



**Back pouch with dual heavy-duty zipper** for additional storage of documents or blueprints



**Plastic drawstring toggle spring** to adjust waist area for desired fit



**Back is made of polyester mesh** for comfort and climate control

## SIZING CHART FOR 770/750 SERIES

	S	M	L	XL	2X	3X
<b>CHEST WIDTH MEASUREMENT</b>	36-38"	40-42"	44-46"	48-50"	52-54"	56-58"
<b>LENGTH FROM HIGH POINT OF SHOULDER</b>	26"	26.5"	27.75"	28.5"	28.5"	29.5"

This sizing chart is relevant for all SITEGEAR 750 Series and 770 Series Vests.

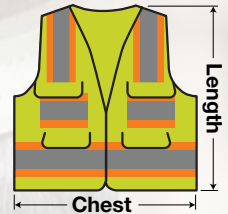

**ANSI Class 3 provide better visibility** - ANSI Class 3 apparel is intended for workers who will be on or near a roadway in which they will be exposed to higher traffic with speeds or reduced sight distances due to inclement weather conditions.



### 770 SERIES

**CLASS 3- ANSI/ISEA**

## PREMIUM CLASS 3 SURVEYOR'S VEST

**SIZES | S M L XL 2X 3X**

- Designed for surveyors and professionals
- Front is made of polyester for durability; back is made of polyester mesh for comfort and climate control
- Padded collar designed for comfort and to help regulate body temperatures
- Fluorescent yellow vest has 4-in wide orange reflective material with 2-in wide silver reflective material stripes
- Quality heavy-duty zipper front closure
- Two exterior mic clips
- Multiple outside pockets for cell phone, flagging tape, radio, pencils, maps, etc., plus inside pockets
- Two spray can holders on the hips of the vest that include straps for keeping the cans in place until they are needed

sku	color	reflective stripping
<b>23-770-FL</b>	Flo-Lime	2-in (51mm) thick strip with 4-in (102mm) wide flo-orange color

### 750 SERIES

**CLASS 2- ANSI/ISEA**

## PREMIUM CLASS 2 SURVEYOR'S VEST

**SIZES | S M L XL 2X 3X**

- Made from durable, heavy-duty ANSI/ISEA compliant polyester and polyester mesh
- Padded collar on the inside
- Back pouch for additional storage
- Multiple outside pockets, two inside pockets, and dual mic clips
- Solid polyester front with mesh back for ultra-cool comfort



**51-18080** NEW!  
**HYBRID PRO FRAMER SET**

SIZES | **M L XL XXL**

The SITEGEAR 18080 is built tough, durable and lightweight to meet both the comfort and needs of professionals on any construction jobsite.

- Crafted from premium heavy-duty top grain leather and 1680d ballistic/nylon fabric
- Easy carry removeable handle design for adjustments and transport
- Wide work belt with new tongue roller buckle
- Leather holders for hammer, tape, combination square, and pry bar
- Pouches made with double-lined ballistic nylon material and gusset design for easy access



Removeable Carry Handles

Wide Heavy-Duty Belt System with steel roller buckle



Hammer Holder

3-Pouch Tool Bag with Tape Holder holds up to a 35" tape, and holders for hand tools, work knife, lumber crayon, chisel, pencils, etc.

3-Pouch Fastener Bag with Holders



**Tough double-lined ballistic material** with gusset design front pockets for easy access to nails and fasteners

<b>51-18080-M</b> Fits waist size 33" - 35"	<b>51-18080-L</b> Fits waist size 36" - 39"	<b>51-18080-XL</b> Fits waist size 40" - 44"	<b>51-18080-XXL</b> Fits waist size 45" - 50"
--	--	---	--

**51-15089**  
**7-POUCH PRO FRAMER SET**

SIZES | **M L XL XXL**

The SITEGEAR 15089 is designed with heavy-duty thick leather, reinforced with durable heavy duty nylon thread and rivets for extra strength and durability.

- Gusset design front pouches for easy access to nails and fasteners
- Riveted and stitched in heavy duty nylon thread for extra strength and durability
- Left side fastener has one extra bag for maximum fastener capacity
- Tape holder with cut-out hole on front for quick and easy access (holds up to a 35-ft tape)
- Pockets/tool holders: 23
- Weight: 6.0lb



Wide Heavy-Duty Belt System with steel roller buckle

Hammer Holder



4-Pouch Fastener Bag with Holders

3-Pouch Tool Bag with Tape Holder holds up to a 35" tape, and holders for hand tools, work knife, lumber crayon, chisel, pencils, etc.



**Gusset design front pouches** for easy access to nails and fasteners



**Riveted and stitched in heavy duty nylon thread** for extra strength and durability

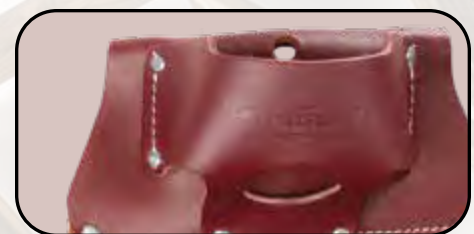

**Tape holder with cut-out hole on front** for quick and easy access (holds up to a 35-ft tape)

<b>51-15089-M</b> Fits waist size 33" - 35"	<b>51-15089-L</b> Fits waist size 36" - 39"	<b>51-15089-XL</b> Fits waist size 40" - 44"	<b>51-15089-XXL</b> Fits waist size 45" - 50"
--	--	---	--

## 51-15089S

### 7-POUCH PRO TOOL BELT RIG

The SITEGEAR 15089S is a complete framer rig set with suspenders. Designed with premium top-grain leather, crafted with durable heavy duty nylon thread and rivets for extra strength and durability.

SIZES | **M L XL XXL**

- Pockets/tool holders: 23
- Gusset design front pouches for easy access to nails and fasteners
- Traditional heavy duty leather suspenders, hand crafted from Bridle leather with large shoulder pads
- Heavy duty spring clips snap to work belt and direct connection loop attachment hardware - fully adjustable
- Riveted and stitched in heavy duty nylon thread for extra strength and durability
- Left side fastener has one extra bag for maximum fastener capacity
- Tape holder with cut-out hole on front for quick and easy access (holds up to a 35-ft tape)



**2**  
YEAR  
WARRANTY

**51-15089S-M**  
Fits waist size 33" - 35"

**51-15089S-L**  
Fits waist size 36" - 39"

**51-15089S-XL**  
Fits waist size 40" - 44"

**51-15089S-XXL**  
Fits waist size 45" - 50"

## 51-15091

### DRYWALLER POUCH W/BELT

**NEW!**

SIZES | **M L XL XXL**

- Pockets/tool holders: 7
- Front and Side mounted hammer ring holder
- Protective leather sheath for saw pocket
- Main inner pouch includes inner loops for tool organization
- Leather 3" ranger style work belt with 2" wide tongue, constructed with high quality bridle leather with nickel plated steel roller buckle
- Size: Large (Fits waist size 36" - 39"). Note: actual fit may vary due to pouches on belt



**2**  
YEAR  
WARRANTY

**51-15091-M**  
Fits waist size 33" - 35"

**51-15091-L**  
Fits waist size 36" - 39"

**51-15091-XL**  
Fits waist size 40" - 44"

**51-15091-XXL**  
Fits waist size 45" - 50"

## 51-15092

### PRO DRYWALLER SET

**NEW!**

SIZES | **M L XL XXL**

- Pockets/tool holders: 17
- Front and Side mounted hammer ring holder
- 3-in ranger style work belt with 2" wide tongue, constructed with high quality bridle leather with nickel plated steel roller buckle
- Protective leather sheath for saw pocket



**2**  
YEAR  
WARRANTY

**51-15092-M**  
Fits waist size 33" - 35"

**51-15092-L**  
Fits waist size 36" - 39"

**51-15092-XL**  
Fits waist size 40" - 44"

**51-15092-XXL**  
Fits waist size 45" - 50"

## 51-10644R PRO DRYWALLER TOOL BAG

- Pockets/tool holders: 7
- Front and Side mounted hammer ring holder
- Protective leather sheath for saw pocket
- Main inner pouch includes inner loops for tool organization
- Fits belt size up to 3-in wide



## 51-15062 4-POUCH PRO FASTENER BAG WITH HOLDERS

- Pockets/tool holders: 10, (left hand type)
- 8-inch deep pouch and holders for angle square, cat's paw loop, 1" blade square, driver bits, pencils
- Built for easy access with the left hand and are worn on the left side of the body
- Main pouch: 9 x 8"; Middle pouch: 7 x 6"; Outer pouch: 5.6 x 5.6"; Upper pouch: 4.6 x 4.6"
- Fits belt size up to 3-in wide



## 51-15018-DB 3-POUCH TOOL BAG WITH TAPE HOLDER

- Pockets/tool holders: 11 (right hand type)
- 8-inch deep pouch, tape holster designed to hold up to a 35' tape, and holders for hammer, work knife, lumber crayon, chisel, small level, pencils
- Built for easy access with the right hand and are worn on the right side of the body
- Main pouch: 9 x 8"; Two Outer pouches: 5.2 x 5.5"
- Fits belt size up to 3-in wide



## 51-15060 3-POUCH PRO FASTENER BAG WITH HOLDERS

- Pockets/tool holders: 9, (right hand type)
- Designed to hold tools and fasteners for framing and carpentry applications
- Holders for angle square, cat's paw loop, 1" blade square, driver bits, pencils, etc
- Fits belt size up to 3-in wide
- Main pouch: 9 x 8"; Outer pouch: 7 x 6"; Upper pouch: 4.6 x 4.6"



## 51-10110-TS 10-POCKET TOOL AND NAIL POUCH

- Pockets/tool holders: 12
- Made of top grain oily-tanned leather
- Left, right side steel swinging hammer ring holders
- Double-gusset front pocket
- Contrasting heavy duty suede trim and stitching
- Fits belt size up to 3-in wide



## 51-10113-TSB 10-POCKET NAIL & TOOL BAG

SIZES | **M** **L** **XL** **XXL**

- Pockets/tool holders: 13
- Made of top grain oily-tanned leather
- Snap-lock pouch handle
- Double-gusset front pocket
- Swinging hammer ring holder; steel tape measure clip; Web loop for pry bar
- Includes 2" web belt (one-size-fits-all)



Shown with tools (not included)



**SITEGEAR** Pro Leather Bags and Pouches are guaranteed with a two (2) year limited warranty. visit our website for more details.

## 51-12035 3-IN RANGER WORK BELT

SIZES | **M L XL XXL**

- Leather 3-in ranger style work belt with 2-in wide tongue
- Constructed with high quality bridle leather with nickel plated steel roller buckle
- Edge stitched for quality, appearance and strength
- Steel rivet reinforcement



## 51-12101 2-IN TOP GRAIN LEATHER BELT

SIZES | **M L XL XXL**

- Leather 2-in work belt- rugged and comfortable
- Constructed with thick bridle leather
- Heavy duty steel roller buckle is reinforced with a nickel finish
- Edge stitched for quality, appearance and strength



## 51-12102 2-IN DOUBLE GROMMET BELT

SIZES | **M L XL**

(Note: The XL for this belt is a one size fits most)

- Double-pronged roller buckle keeps it secure
- 2-in poly web belt is durable and weather resistant
- Edge stitched with heavy duty nylon thread
- Ends are finished top grain oil-black leather for comfort and appearance



## HOW TO SIZE YOUR WORK BELT?

AVAILABLE SIZES (All Belts)

<b>M</b> Medium Fits 33" to 35"	<b>L</b> Large Fits 36" to 39"	<b>XL</b> X-Large Fits 40" to 44"	<b>XL</b> X-Large Fits 45" to 50"
------------------------------------	-----------------------------------	--------------------------------------	--------------------------------------

To size your tool belt, place your existing tool belt on an even surface and measure it from the end of the buckle to the most commonly used hole. Mark the measurement with a pencil. The hole closest to your measurement.



If you do not have a current tool belt to measure, you can get an approximate mid range measurement by adding 4-inches to your pant waist size.

## 51-15009 LEATHER WORK SUSPENDERS

- Traditional heavy duty leather suspenders
- Hand crafted from Bridle leather with large shoulder pads
- Heavy duty spring clips snap to work belt
- Direct connection loop attachment hardware
- Fully adjustable

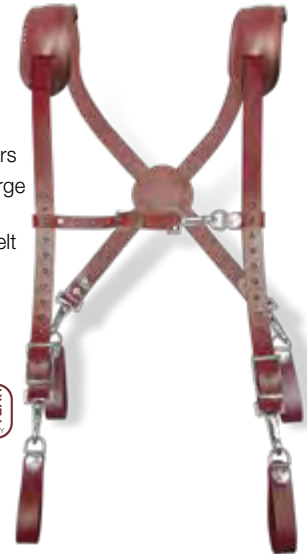

**Large leather shoulder pads** for comfort and relieves hips and lower back strain



**Adjustable chest strap with spring clip** keeps shoulder straps securely in place

## 51-15055 HYBRID SUSPENSION SYSTEM

- Crafted from premium heavy-duty top grain leather and 1680d ballistic/nylon fabric
- D-Ring to easily hang and store entire rig
- Comfortable padded and contoured yoke
- Heavy duty spring clips snap on and off with leather loop attachments fits up to 3-in belt
- Easy on and off, just release the adjustable chest strap
- Fully adjustable



**Extremely comfortable, padded and contoured lined yoke** relieves hips and lower back strain



**Loop attachment system for up to 3" belt with spring release clips** for easily securing to your tool belt system

## 51-15024

### LARGE PRO UTILITY BAG

- Pockets: 1
- Large pouch designed to hold fasteners for framing and carpentry applications
- Designed with an extra deep bag
- Fits belt size up to 3-in wide
- Main pouch: 10" x 10.5"

10" x 10.5"  
Single pouch



## 51-15019

### COMPACT PRO UTILITY BAG

- Pockets: 1
- Designed to hold fasteners (or use as a tool holder) for framing and carpentry applications
- Compact design is ideal for that third bag in the back
- Fits belt size up to 3-in wide
- Main pouch: 7.75" x 8"

7.75" x 8"  
Single pouch



## 51-11220

### PRO HAMMER HOLDER

- Made of heavy duty custom-tanned top grain leather
- Steel hammer ring is wedged between two layers of leather and stitched with heavy duty nylon thread
- Rivets and Edge stitching in contrasting heavy duty nylon thread for durability and maximum life
- Slits to fit up to 3-in (76mm) belt



## 51-11422P

### LEATHER KNEE PADS

- Wide adjustable leather buckle strap with steel buckle
- Made of top grain leather
- Thick water repellent soft felt lining shaped to fit your knees and add extra comfort
- Stitched with heavy duty nylon thread and riveted for extra strength
- One size fits most



## 51-11137

### HIGH MOUNT TAPE HOLDER

- Made of heavy duty top grain leather
- Belt worn (up to 3-in belt)
- Made to fit up to 35-ft tape
- Rivets for durability
- Cut-out bottom for easy access to tape



## 51-11230

### TAPE HOLDER

- Made of heavy duty top grain leather
- Belt worn (up to 3-in belt)
- Made to fit 25-ft to 30-ft tape
- Rivets and edge stitching in contrasting heavy duty nylon thread for durability and maximum life
- Cut-out bottom for easy access to tape



## 51-B2617 PRO FRAMER BALLISTIC COMBO TOOL BELT

- 6-piece carpenter's combo is the perfect belt for any tradesman or professional builder's needs
- 28 convenient pockets
- Designed with rugged, lightweight ballistic poly fabric and double-stitched pockets to survive all wear/tear
- Padded, adjustable suspenders
- Wide padded belt system with steel roller buckle for comfort - fits waist sizes: 29-inches to 46-inches
- Removable carry handles for easy carrying
- Weighs 4.1lb (1.86kg)



**51-B2617**  
Fits waist size 29" - 46"



## 51-B4122 PRO BUCKET TOOL ORGANIZER

- Fits most 5 gallon buckets
- Multiple pockets: includes pocket for drill holster and pockets for organizing drill bits
- Made of durable, rugged 600D poly fabric



## 51-B5680 ELECTRICIAN'S TOOL POUCH

- Three (3) main pockets allow for easy access of your tools and parts
- Steel loop hammer holder, snap hook and electrical tape web strap
- Flat bottom design helps stabilize pouch when placed on surfaces



sku	what's included
51-B5680	Electrician's Tool Pouch
51-B5680-B	Electrician's Tool Pouch with 2-in Web Belt (One Size Fits Most)

## 51-B1528 11" ELECTRICIAN & MAINTENANCE TOOL CARRIER

- 32 pockets with built-in measuring tape clip
- Flapped external pocket; Large open-top center cavity
- Water-resistant Ballistic quality material, made of reinforced 600D polyester, reinforced rivets
- Durable molded polypropylene base; Non-slip, ergonomic carrying handle with key clip
- Inner dimensions: 9.25" L x 10.5" D x 10.25" H



## 51-B1535 18-IN WIDE MOUTH TOOL BAG

- Wide mouth top and large interior compartment with HD zipper
- Durable water-resistant Ballistic quality material, made of reinforced 600D polyester, reinforced rivets
- 19 pockets, slots - includes a zippered pocket
- Durable molded polypropylene base
- Padded adj. shoulder strap with non-slip handle
- Weighs 3.6lbs (1.63kg)



## #G001 PLUMB LINE REEL FOR SURVEYOR

- Allows for simple and fast plumb bob set-up and adjustments
- Designed for use in the surveying field
- Stainless steel wear-guard
- 6-1/2 ft (1.9m) Red string



sku	description
<b>15-G001</b>	Gammon Reel® Plumb Line Reel for Surveyors (6-1/2 foot)

## #G012 PLUMB LINE REEL FOR CONSTRUCTION

- Allows for simple and fast plumb bob set-up and adjustments
- Designed for use in the construction field
- 12-ft (3.6m) fluorescent-red string
- Power return quickly retracts, eliminating tangled string



sku	description
<b>15-G012</b>	Gammon Reel® Plumb Line Reel for Construction (12-ft)
<b>15-G012B</b>	Gammon Reel® Plumb Line Reel for Construction (12-ft), Black

## #G015 GAMMAGNET® MAGNETIC CASE FOR #G001

- Provides versatility for construction plumb line reel
- Strong neodymium (rare earth) magnet securely mounts to any steel surface
- Built-in nail sleeve for use with wood surfaces



sku	description
<b>15-G015</b>	GAMMAGNET® magnetic case, for use with #G012

## #G002 REPLACEMENT STRING

- Refill string is made of high-quality nylon
- Innovative bobbin case keeps string wound and safely stowed
- 24-yd replacement string
- Strong 72-lb test nylon string
- Choice of six (6) available colors



item#	color	length (yards)	length (feet)	length (meters)
<b>15-G002-O</b>	Original Orange	24 yards	72-ft	22m
<b>15-G002-FR</b>	Fluorescent Red	24 yards	72-ft	22m
<b>15-G002-FY</b>	Fluorescent Yellow	24 yards	72-ft	22m

## PLUMB BOBS

SitePro plumb bobs are precision machined for perfect balance and treated for a lasting finish.

- Brass construction
- Steel ASA screw cap allows storage for extra point
- Includes a hardened steel point with ASA thread- stored inside cap



sku	wgt	sku	wgt
<b>15-016</b>	16oz (454g)	<b>15-024</b>	24oz (680g)
<b>15-018</b>	18oz (510g)	<b>15-032</b>	32oz (907g)

## PLUMB BOB SHEATHS

- Heavy duty and riveted for long life
- Made of top grain saddle leather
- Strong metal snap secures bob in sheath



sku	description	designed for
<b>15-1016</b>	Small Plumb Bob Sheath	16oz - 18oz Plumb Bob
<b>15-2432</b>	Large Plumb Bob Sheath	24oz Plumb Bob

## CONTRACTOR KITS GAMMON REEL KIT W/ PLUMB BOB

The Gammon Reel kits are ideal for the contractor. Leather sheath keeps your plumb bob and Gammon Reel handy at your side.

- Riveted and stitched in heavy duty nylon thread for extra strength and durability
- Snap button straps secure plumb bob and Gammon Reel in pockets
- Slits for up to 3-in belt insertion
- Gammon Reel and plumb bob included



sku	plumb bob	plumb reel
<b>15-1021GR16KIT</b>	16oz (#15-016)	12-ft (#15-G012)
<b>15-1021GR18KIT</b>	18oz (#15-018)	12-ft (#15-G012)





## SURVEY BOOKS

The SitePro survey books are made of quality white paper with extra-stiff hard cover book. Published on quality paper, cover protected by a water barrier with blind embossing.

- 80 Sheets (160 pages)
- Quality content paper
- Ruled light blue with red vertical lines
- Hardback, orange color
- Size: 4-1/2" x 7-1/4"
- Reference tables/diagrams in back section

17-325-L LEVEL BOOK

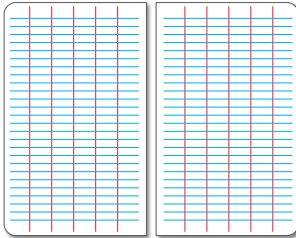

17-350-T FIELD BOOK

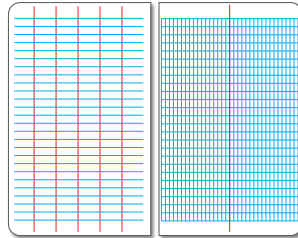

sku	description	left page	right page	#pages
17-325-L	Level Book	Six (6) Vertical Columns	Six (6) Vertical Columns	160
17-350-T	Field Book	Six (6) Vertical Columns	8 x 4 Grid	160

## 13-642

### TOPOGRAPHIC ABNEY LEVEL

- Square sighting tube with internal focusing telescope
- Dual interchangeable arcs: one arc graduated in percentage of grade/degrees (bi-directional, 0° to 60°) and one graduated in percentage of grade/topographic scale
- Length: 6-3/8" (16.1cm)
- Includes belt loop case



## 651 / 661

### TRANSIT COMPASS

- Graduated circle for optimal versatility
- Dampened for superior stability
- Includes velvet lined, belt-loop case for storage and transport



## 13-632

### 6" BRASS HAND LEVEL

- 2-power magnification
- 6-in (15.2cm) long draw eyepiece extends to 7-1/2 in (19.1cm)
- Internally mounted bubble assembly



sku	description
17-651	Compass, Transit Pocket 0-360 Degrees
17-661	Compass, Transit Pocket Quadrants

## 13-590

### 2.5X HAND LEVEL

- 2.5-power magnification
- Convenient pocket-sized tool for establishing a level line of sight
- Ideal for preliminary survey and simple distance estimation



- Stadia and vertical lines
- Length: 5-in (12.7cm)
- Includes carrying case

## 17-911

### DOUBLE RIGHT ANGLE PRISM

- Large field of view and foresight viewing glass
- Center lens permits foresight viewing
- Step off angles of 90° and 180°
- Includes carrying case



## 43-D620

### 2X SIGHTING HAND LEVEL

- Ideal for preliminary survey and simple distance estimation
- Sturdy impact resistant aluminum body and easy-to-read protected vial



- 2-power fixed magnification
- Pocket clip

## 17-100

### 4-DIGIT TALLY COUNTER

- Four-digit mechanical counter counts up to 9999, with reset to zero
- Audible click
- Easy reading digits with protective window





# **SALAMANDER®**

## MARKING SYSTEMS

Stronger, Longer Lasting, and Brighter in All Environments.



The SALAMANDER® brand is focused on providing professionals in the surveying, construction and industrial market with durable, all-environment, diverse, high-visibility products.

Our marking systems are highly visible, long-lasting marking products for reference points, stake markers, underground utilities, and many other uses. With available in bright APWA utility code colors, they are durable and cost-effective.

Visit your local SitePro Retailer, or Contact us toll-free for more information and where to buy.



  
Ask For The  
**SALAMANDER**  
Markers for Your  
Next Job.

**STAKE FLAGS  
STEEL WIRE FLAGS**

Ideal to ensure consistent communication and long-lasting visibility for utility construction, line locating, forestry, and landscaping.

- Steel wire constructed of rust-resistant alloy steel
- Flags made of long lasting PVC material with high visibility ink color
- Tear resistant for high performance to -20°F
- Flag is glued to staff for durability
- **Packaged in Box of 1000 Flags** (10 bundles of 100 each per box)



sku	flag size	length	color	flags in box	box gross wgt
<b>19-F4521-B</b>	4" x 5"	21"	Blue	1000	23lbs
<b>19-F4521-G</b>	4" x 5"	21"	Green	1000	23lbs
<b>19-F4521-GL</b>	4" x 5"	21"	Glo-Lime	1000	23lbs
<b>19-F4521-GO</b>	4" x 5"	21"	Glo-Orange	1000	23lbs
<b>19-F4521-GP</b>	4" x 5"	21"	Glo-Pink	1000	23lbs
<b>19-F4521-R</b>	4" x 5"	21"	Red	1000	23lbs
<b>19-F4521-W</b>	4" x 5"	21"	White	1000	23lbs
<b>19-F4521-Y</b>	4" x 5"	21"	Yellow	1000	23lbs

sku	flag size	length	color	flags in box	box gross wgt
<b>19-F4530-B</b>	4" x 5"	30"	Blue	1000	31lbs
<b>19-F4530-G</b>	4" x 5"	30"	Green	1000	31lbs
<b>19-F4530-GL</b>	4" x 5"	30"	Glo-Lime	1000	31lbs
<b>19-F4530-GO</b>	4" x 5"	30"	Glo-Orange	1000	31lbs
<b>19-F4530-GP</b>	4" x 5"	30"	Glo-Pink	1000	31lbs
<b>19-F4530-R</b>	4" x 5"	30"	Red	1000	31lbs
<b>19-F4530-W</b>	4" x 5"	30"	White	1000	31lbs
<b>19-F4530-Y</b>	4" x 5"	30"	Yellow	1000	31lbs

**FTP SERIES  
SALAMANDER®  
FLAGGING TAPE, 4MIL**
**NEW COLORS!**

- Bright, long-lasting high visibility glo-colors
- -30°F temperature resistance
- Smooth, bright, and reflective appearance
- 4.0 mil thickness
- Environmental protection material
- **Packaged in box of 12 rolls**



sku	ribbon size	color	ribbon length
<b>19-FTP-LG</b>	1-3/16" (30mm)	Glo-Lime/ Green	150' (45m)
<b>19-FTP-OG</b>	1-3/16" (30mm)	Glo- Orange	150' (45m)
<b>19-FTP-PG</b>	1-3/16" (30mm)	Glo-Pink	150' (45m)
<b>19-FTP-RG</b>	1-3/16" (30mm)	Glo-Red	150' (45m)
<b>19-FTP-YG</b>	1-3/16" (30mm)	Glo- Yellow	150' (45m)
<b>19-FTP-B</b>	1-3/16" (30mm)	Blue	150' (45m)
<b>19-FTP-G</b>	1-3/16" (30mm)	Green	150' (45m)
<b>19-FTP-W</b>	1-3/16" (30mm)	White	150' (45m)

**SW6 SERIES  
6-IN STAKE WISKER MARKERS**
**NEW!**

Ideal for quick, easy identification for survey and construction sites, reference points, stake markers, underground utilities, and so much more.

- Available in bright APWA and international utility code colors: blue, green, glo-orange, glo-pink, red, white, yellow.
- Highly visible, durable and cost-effective
- Installs quickly and easily, fits all wooden stakes and 60-penny nails



sku	height	color	whiskers
<b>19-SDW6-B</b>	6" (150mm)	Blue	500
<b>19-SDW6-G</b>	6" (150mm)	Green	500
<b>19-SDW6-FO</b>	6" (150mm)	Glo- Orange	500
<b>19-SDW6-FP</b>	6" (150mm)	Glo-Pink	500
<b>19-SDW6-R</b>	6" (150mm)	Red	500
<b>19-SDW6-W</b>	6" (150mm)	White	500
<b>19-SDW6-Y</b>	6" (150mm)	Yellow	500

- **Packaged in Box of 500 Wiskers** (20 bundles of 25 wiskers each per box)



## PM 220 SERIES

### DUAL-TIP PERMANENT MARKERS FOR PROFESSIONALS



The SitePro PM 220 Series is a six inch durable-poly barrel permanent marker with dual tip design to maximize useage. Features heavy-duty chisel felt-tip and fine felt-tip on other end with reinforced nib construction.

- Works great for marking on wood, metal, and more.
- Fast drying with fade resistant non-toxic permanent ink
- 6-inch high strength poly barrel is leak-proof
- Sold in **box of 12 markers** each



**Side One**  
Large (7mm) Chisel Tip

**Side Two**  
Fine Tip

sku	description	ink color
17-PM220-B	Permanent Marker for Professionals	Black
17-PM220-R	Permanent Marker for Professionals	Red

## 207

### GIANT CONCRETE SCRIBE

- Ideal for fine line marking on metal and stone
- Precision ground carbide scribe tip
- Machined aluminum handles with diamond knurling for sure grip
- Pocket clip and protective cap

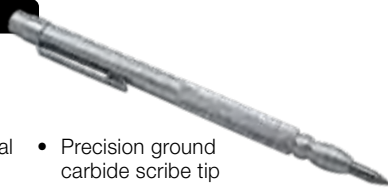

sku	description	tip
17-207	7-1/2 in Concrete Scribe, with Replaceable Tip	Carbide
17-201-10	Replacement Tip (Pack of 10)	Carbide

## 17-401

### 14-IN MARKING PINS

- Ideal for land surveyors, also known as chaining pins.
- 14-in (35.5cm) length; 3/16-in (4.8mm) spring steel, heat-treated
- Powder-painted red and white, alternating at each 1-inch (25.4mm)
- Includes **eleven (11) marking pins**
- Weigh 1.6lb (.73kg) per 11 pins



Leather Quiver available on [page 39](#)

## 17-411

### CARRYING RING FOR MARKING PINS

- 3/16-in (4.8mm) spring steel, heat-treated
- Power-painted white
- Eye with slip hook locks ring to secure pins



## 700 SERIES

### SURVEY MARKERS

- Cast from solid brass
- Ideal for boundary or general survey markers
- Shank is ribbed to prevent turning or loosening
- Non-glare finish
- Available in both flat and domed head design



sku	length	head type
19-700	1-3/8 in (34.9mm)	Flat
19-701	2 in (50.8mm)	Flat
19-702	2-1/2 in (63.5mm)	Flat
19-703	3 in (76.2mm)	Flat
19-705	2 in (50.8mm)	Domed
19-706	2-1/2 in (63.5mm)	Domed
19-707	3 in (76.2mm)	Domed

## DWSITEPRO

### HI-MAGNETIC MASONRY NAILS

- 3 times easier to locate than other nails on the market
- Most preferred by professionals
- Zinc plated to resist corrosion
- Large targeted center point
- 6 sizes available from 2-1/2 to 3/4 inches in length



sku	Shank Length	Shank Diameter	head diameter	ct per box
20-751	3/4 in (19.05mm)	1/8 in (3.18mm)	5/16-in	100
20-752	1 in (25.4mm)	3/16 in (4.76mm)	3/8-in	100
20-753	1-1/4 in (31.75mm)	3/16 in (4.76mm)	1/2-in	100
20-754	1-1/2 in (38.1mm)	1/4 in (6.35mm)	9/16-in	100
20-755	2 in (50.8mm)	1/4 in (6.35mm)	9/16-in	100
20-756	2-1/2 in (63.5mm)	1/4 in (6.35mm)	9/16-in	100

## 19-750

### 3/4" STAKE TACKS, ZINC PLATED

- New and improved zinc plated surveyor tacks
- 3/4-in length
- 1lb (0.45kg) per box
- Approximately 750 tacks per box



sku	description	wgt
19-750	3/4-in (19mm) Stake Tacks, Zinc-Plated	1lb (0.45kg)
19-BALL750	3" (76mm) Rubber Sponge Tack Ball with Loop	



Our product line of SiteMAX™ bags are constructed of high strength Ballistic nylon-fiber material with heavy duty hardware and reinforcement stitching. The internal seams of the SiteMAX Ballistic bags are bound to prevent fraying which provide maximum toughness and durability. Select from the many styles designed to fit your needs in the field or on the jobsite.

### 21-B81520

#### BALLISTIC TRIPOD BAG

- Designed to hold most major brands of aluminum or wood tripods
- Constructed of high strength ballistic nylon-fiber material with **inner reinforcement lining**
- High-grade abrasion-resistant material on bottom and 8-in (20.5cm) up the side is tough and rugged in wet, dry, and extreme conditions
- Unique double draw string design for quick closure of bag once tripod is inside
- Three (3) large pockets made of tough nylon fiber material with pull tab to store other gear
- Heavy duty adjustable padded shoulder strap and hand loop for easy handling and carry



### 21-B248

#### 48" BALLISTIC LATH BAG

- Hold and carry 48" (122cm) laths
- Constructed of high strength ballistic nylon-fiber material with inner lining
- High-grade abrasion-resistant material on bottom and 8-in (20.5cm) up the side is tough and rugged in wet, dry, and extreme conditions - with moisture control airlent grommet
- Three (3) large 8" W x 10" D (20.5cm x 25.4cm), pleated outside pockets for markers, paint, and other supplies
- Heavy duty adjustable padded shoulder strap and hand loop for easy handling and carry
- Overall size: 45" T x 8" W (114.5cm x 20.5cm)
- Wgt: 2.9lb (1.3kg)



### 21-B236

#### 36" BALLISTIC LATH BAG

- Hold and carry 36" (92cm) lath
- Constructed of high strength ballistic nylon-fiber material with inner lining
- High-grade abrasion-resistant material on bottom and 8-in (20.5cm) up the side is tough and rugged in wet, dry, and extreme conditions - with airlent grommet
- Three (3) large 8" W x 10" D (20.5cm x 25.4cm), pleated outside pockets with pull tab for markers, paint, and other supplies
- Heavy duty adjustable padded shoulder strap and hand loop for easy handling and carry
- Overall size: 34" Tall x 8" Wide (86.4cm x 20.5cm)
- Wgt: 2.45lb (1.1kg)



### 21-B758

#### 24" BALLISTIC STAKE BAG

- Designed to hold 24-inch (60cm) wood survey stakes or iron rebar
- Constructed of high strength ballistic nylon-fiber material with inner lining
- High-grade abrasion-resistant material on bottom and back side is tough and rugged in wet, dry, and extreme conditions - with airlent grommet
- Heavy duty adjustable padded shoulder strap and hand loop
- Five (5) Pockets: Three (3) large 8" W x 10" D (20.5cm x 25.4cm), pleated front outside pockets for markers, paint, and other supplies; Two (2) 6.5" W x 9" D (2.6cm x 22.9cm) pleated side pockets.
- Overall inner size: 24" L x 10" W x 14" H (61 x 25.4 x 35.6cm). Wgt: 2.95lb (1.34kg)



### 21-B718

#### 18" BALLISTIC STAKE BAG

- Designed to hold 18-inch (46cm) wood survey stakes or iron rebar
- Constructed of high strength ballistic nylon-fiber material with inner lining
- High-grade abrasion-resistant material on bottom and back side is tough and rugged in wet, dry, and extreme conditions - with moisture control airlent grommet
- Heavy duty adjustable padded shoulder strap and hand loop
- Five (5) Pockets with three (3) large 6" W x 10" D (15.3 x 25.4cm), pleated front outside pockets for markers, paint, and other supplies
- Overall inner size: 19" L x 11" W x 14" H (48.5 x 28.0 x 35.6cm). Wgt: 2.55lb (1.16kg)



### 21-BPC50P

#### BALLISTIC SPRAY CAN HOLDER WITH POCKETS

- Designed to hold a standard size marking paint can at your hip for easy access
- Pockets to hold a folding rule, marker pens, pencils
- Constructed of high strength ballistic nylon-fiber material for durability and longevity
- Webbed belt loop fits a 2.25-in wide belt
- Webbing strap with Velcro to safely hold paint can in place
- Overall, inside: 7.5" x 3" (19.1 x 7.6cm). Wgt: 0.25lb (0.12kg)



### 21-BPC50

#### BALLISTIC SPRAY CAN HOLDER

- Designed to hold a standard size marking paint can
- Webbed belt loop fits a 2.25-in wide belt
- Constructed of high strength ballistic nylon-fiber material for durability and longevity
- Overall, inside: 7" x 3" (18cm x 7.6cm). Wgt: 0.10lb (0.05kg)





### 21-236

#### 36" REINFORCED LATH BAG

- Hold and carry 36" (92cm) lath
- High strength fiber material with tough, waterproof and abrasion-resistant material at the bottom and 6" (15cm) up the side
- 8" (20cm) diameter bucket style bottom
- Three (3) large, pleated outside pockets for markers, paint, and other materials
- Heavy duty adjustable shoulder strap and hand loop
- Overall inside: 8" x 33.5" (20cm x 84cm)
- Color: Hi-vis orange



### 21-248

#### 48" REINFORCED LATH BAG

- Hold and carry 48" (122cm) lath
- High strength fiber material with tough, waterproof and abrasion-resistant material at the bottom and 6" (15cm) up the side
- 8" (20cm) diameter bucket style bottom
- Three (3) large, pleated outside pockets for markers, paint, and other materials
- Heavy duty adjustable shoulder strap and hand loop
- Overall inside: 8" x 45" (20cm x 114cm)
- Color: Hi-vis orange



## HEAVY DUTY DESIGNS FOR PURPOSE, DURABILITY, AND STYLE

### 21-28102

#### 38" LATH BAG, HEAVY-DUTY WITH HANDLES

- Constructed with high strength fiber material; tough with heavy duty stitching and reinforced bottom
- Designed to hold up to 50 lath or rebar
- Bottom of bag features tough, waterproof and abrasion-resistant composite material
- 7 large pockets and slots: One (1) large pocket, two (2) small pockets, one (1) can holder, 3 small market slots
- Heavy duty adjustable padded shoulder strap and two hand loops
- Overall dimensions: 9" x 38" (23cm x 97cm)
- Color: Hi-vis orange



### 21-758

#### 24" STAKE BAG, HEAVY-DUTY

- Designed to hold 24-inch (60cm) wood survey stakes or iron rebar
- Five (5) large pockets made of tough nylon fiber material to store flagging tape, nails, or other gear
- Constructed with high strength fiber material; tough with heavy duty stitching and reinforced bottom
- Bottom of bag features tough, waterproof and abrasion-resistant composite material
- Heavy duty adjustable shoulder strap for carrying
- Grommet drain holes are positioned at both ends of bag



### 21-718

#### 18" STAKE BAG, HEAVY-DUTY

- Designed to hold 18" wood survey stakes or iron rebar
- Constructed with high strength fiber material; tough with heavy duty stitching and reinforced bottom
- Bottom of bag features tough, waterproof and abrasion-resistant composite material
- Heavy duty adjustable shoulder strap for carrying
- Five (5) large pockets made of tough nylon fiber material to store flagging tape, nails, or other gear
- Grommet drain holes are positioned at both ends of bag





### 21-81540

## 56" GPS TRIPOD BAG, HEAVY-DUTY

The SitePro heavy duty GPS tripod bag is designed to protect and carry heavy duty GPS antenna tripod (#09-100).

- Ends of the bag are protected with tough, waterproof and abrasion-resistant composite material
- Heavy duty adjustable shoulder strap is detachable
- Two hand loops with built-in Velcro® grip



- Constructed with high strength fiber material; tough, waterproof and abrasion-resistant material at bottom
- Heavy duty zipper and stitching for greater durability
- Overall Inside: 8" x 56" (20.3cm x 142cm)

### 21-81520

## HEAVY DUTY TRIPOD BAG

- Holds all major brands of aluminum or wood tripods
- Constructed with high strength fiber material; tough with heavy duty stitching and reinforced bottom
- Double pull string ties at the top
- Three (3) large pockets made of tough nylon fiber material to store other gear
- Grommet drain hole at end of bag
- Heavy duty adjustable shoulder strap for carrying
- Weight: 1.85lb (0.85kg)



### 21-2547

## TOP LOADING FIELD CASE FOR TOTAL STATION, HEAVY-DUTY

This heavy duty padded field case fits most total stations. Designed as a backpack and constructed with water-resistant nylon.

- Constructed with high strength fiber material; tough with heavy duty stitching and reinforced bottom
- Designed to load instrument from the top of case
- 2-in thick foam padding on all inner sides
- Bottom of case is protected with a tough waterproof and abrasion-resistant composite material
- Inside dimensions for total station: 14.0 x 9.0 x 7.0-in (36 x 23 x 18cm)
- Weight: 6.75lb (3.1kg)



### 21-PC50

## SPRAY CAN HOLDER

- Holds a paint can on hip for easy access; designed to carry a standard size spray-paint can
- Heavy duty nylon construction with nylon webbing belt loop that fits up to a 2-in wide belt
- Color: Hi-vis orange
- Wgt: 0.14lb (0.06kg)



### 21-PC50P

## PAINT CAN HOLDER WITH POCKETS

- Paint can pocket lined with reinforcement for easy in and out of can
- Designed with pockets to hold a folding rule (which includes a Velcro strap), marker pens, pencils, and other items
- Velcro safety strap
- High strength fiber material that is tough and abrasion-resistant
- Heavy duty belt loop with reinforced stitching that fits up to a 2-in wide belt



### 21-2542

## LARGE PADDED BAG

- Extra thick padding on all inner sides for protection of your device
- Suitable for use with triple tilting prism
- Strap handles for carrying
- Heavy-duty zipper
- Inside dimensions: 9" x 7" x 2" (22.9cm x 17.8cm x 5.1cm)
- Weighs 0.5lb (0.34kg)



### OTHER CASES



### 21-2581

## JUMBO PADDED BAG

- Ideal for triple prisms and prism targets or tribrach kits
- Thick padded interior
- Heavy-duty zipper
- Inside dimensions: 10" x 9.5" x 3" (25.4cm x 24.1cm x 7.7cm)
- Outside dimensions: 12" x 12.5" x 8" (30.5cm x 32cm x 20.3cm)
- Outside pocket
- Weighs 1.06lb (0.48kg)



sku	description	designed for
21-1200	Padded bag, tribrach	05-1200 Series tribrachs
21-2010	Padded bag, prism	03-2010M, 03-1010 prisms

## BIM CONSTRUCTION TARGETS

TARGETS FOR BUILDING INFORMATION MODELING (BIM)

### 03-RS21

- Datum marker for walls
- Elastic stubs ensures stable datum
- Size: 50mm x 80mm
- Self-adhesive



### 03-RS30

- BIM Target for fixed points
- 30mm target reflector w/ crosshair; range approx. 80m (262-ft)
- Size: 60mm x 90mm



### 03-RS40

- BIM target with crosshairs
- Attachment depth: 23mm
- Size: 60mm x 90mm



## SMART SURVEY TARGETS

FOR QUICK POSITIONING WITH THE TACHYMETER AND ALL COMMON MEASURING INSTRUMENTS

### 03-RS50

- 30mm reflective target
- Range: 10m to 100m
- Size: 60mm x 75mm
- Available in red and grey



### 03-RS60

- 40mm reflective target
- Range: 10m to 100m
- Size: 60mm x 75mm
- Available in red and grey



### 03-RS70

- Crosshair target
- Range: 10m to 100m
- Size: 60mm x 75mm
- Available in red\* and grey



### 03-RSAKZ6

- 30mm reflective target
- Range: 10m to 100m
- Size: 60mm x 75mm
- Available in red and grey



### 03-RS80

- "Roof-shape" angle
- Two (2) 40mm reflective targets
- Angle of approx. 90 degrees
- Available in red and grey



### 03-RS90

- 90-degree angle
- Permits sighting surveying point from almost any position
- Three (3) 40mm reflective targets
- Available in red and grey



### 03-RSAK80

## 40MM SMART MARKER TARGET

- Reflective marker Adapter w/ RS80
- XYZ coordinates ensure 3-D observations
- Range: 100m (328-ft)
- Size: 120mm x 75mm x 50mm
- 40mm reflective targets



### 03-RSAK130

## 40MM ANGLE MARKER TARGETS

- Used on rails, bridges, tunnels, dams, buildings, supports
- Size: 100mm x 35mm x 30mm
- 30mm reflective targets on backing plate
- Target range approx. 80m (262-ft)
- Available in red and grey



### 03-RS183

## 180° SWIVELING SURVEY MARKER

- When using tachymeter and total stations, the reflective mark can always be aligned precisely with the measuring instrument
- Reflective target can be rotated 180° making it possible to use the same survey point from different directions
- Offset: 0; Height of tilting axis: 30mm
- Available in red and grey



### 03-RS193 /03-RS193M

## 30MM REFLECTIVE TARGET W/ 360° ROTATION

- Rotates 360° for unlimited tilting and turning
- Range approx. 80m
- Offset: 0; Height of tilting axis: 45mm
- 03-RS193M features magnetic base plate for easy installation on steel structures
- Available in red and grey\*



\*Available through Special Order



**03-RS96**  
**STAKEOUT REFLECTIVE TARGET**

- Ideal for stake-out work on the batter board and on a floor slab
- Exact measuring of the survey point on the floor slab
- Foldable- fits in shirt pocket
- 20mm target reflector



**RSMP10/12/15**  
**MINI-PRISM SYSTEMS**



sku	prism	size (mm)	offset
<b>03-RSMP10*</b>	12.7mm	19 x 33.8	10.1 (Leica +24.3)
<b>03-RSMP12*</b>	17.5mm	25 x 64.5	-11.3 (Leica +23.1)
<b>03-RSMP15</b>	12.7mm	35 x 100 x 30	-10.1 (Leica +24.3)

*\*Available through Special Order*

**TILTING MINI PRISM SYSTEMS**

FOR MONITORING MORE QUICKLY AND PRECISELY

**03-RSMP280**  
**17.5 MM SWIVELING MINI PRISM, 180° ROTATION**

- Twistable, extensible mini-prism made with a rugged plastic housing system
- Offset -16.9; height of tilting axis: 30mm
- Accuracy is 5 arc sec (+/- 2 arc sec)
- Available in red and grey



**03-RSMP380**  
**25.4 MM SWIVELING MINI PRISM, 180° ROTATION**

- Twistable, extensible mini-prism made with a rugged plastic housing system
- Offset -16.9; height of tilting axis: 30mm
- Height: 13.125mm (+/- 0.2mm)
- Accuracy is 5 arc sec (+/- 2 arc sec)
- Available in copper coated (03-RSMP380-C-G, 03-RSMP380-C-R\*) and silver coated (03-RSMP380-S-G, 03-RSMP380-S-R) prismred; Colors available: red and grey



**03-RSMP290 / 03-RSMP290M**  
**17.5 SWIVELING MINI PRISM, 360° ROTATION**

- 17.5mm mini-prism
- Offset -16.9 (Leica +24.4)
- Height of tilting axis: 45mm
- Range: 300m to 500m (ATR mode ranges)
- 03-RSM290M features magnetic base plate for easy installation on steel structures
- Available in red and grey



**03-RSMP390 / 03-RSMP390M**  
**25.4 SWIVELING MINI PRISM, 360° ROTATION**

- 25.4mm mini-prism
- Offset -16.9 (Leica +17.5)
- Height of tilting axis: 45mm
- Range: 500-700m (ATR ranges)
- 03-RSM390M has magnetic base plate for easy installation on steel structures
- Available in copper coated (03-RSMP380-C) and silver coated (03-RSMP380-S) prismred; Colors available: red and grey



**03-RSPC10M / RSPC20M**  
**PROTECTIVE CAP MAGNETIC**

- Protect prisms and reflective targets from fouling.
- RSPC10M and RSPC20M have built in magnetic system to securely attach and cover the target - Ideal for points that are hard to reach or on a tunnel roof
- Available in red and grey



**03-RSPC50**  
**METAL CUBE WITH 5/8-11 FEMALE THREAD**

- With its 5/8-11 internal thread, the metal cube RSPC50 can be screwed onto a prism pole
- The magnetic protective caps (RSPC10M and RSPC20M) can thereby be easily fitted over and removed from the plastic case of the prisms, even from difficult positions, and refitted at any time



sku	Used for	cap type
<b>03-RSPC10*</b>	RSMP280	Standard
<b>03-RSPC10M*</b>	RSMP280	Magnetic
<b>03-RSPC20*</b>	RSMP380	Standard
<b>03-RSPC20M*</b>	RSMP380 (Grey is available)	Magnetic

*\*Available through Special Order*

**03-RSFP-X80**

**FIXPOINT ADAPTER HOLDER FOR TILTING PRISMS AND TARGETS**

- Plastic mounting system for **RS183** reflector targets, as well as **RSMP280** and **RSMP380** mini-prisms
- Provides one single survey point for total stations (with RS183), robotic total station (with RS380), etc.
- Available in red\* and grey



**03-RSFP-X90**

**RESTORE POINT FOR MAGNETIC BASE PLATE**

- Restore point made of stainless steel, for **RS193M**, **RSMP190M**, **RSMP290M** and **RSMP390M**
- Magnets in the floor plate hold the reflective target or the mini-prism exactly on the desired point



**RSZ-SERIES**

**REFLECTIVE ADHESIVE TARGETS**

- Recommended for carrying out distance measurements using a tachymeter or total station
- Reflective target with red crosshairs
- **Sheet of 10 targets (03-RSZ6-4 has 4 targets per sheet)**

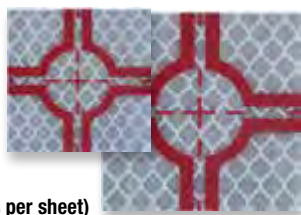

sku	contains	qty/sheet	range (approx)	target size
<b>03-RSZ2-10</b>	Sheet of 21mm Targets	10	50m	21mm x 21mm
<b>03-RSZ3-10</b>	Sheet of 30mm Targets	10	80m	30mm x 30mm
<b>03-RSZ4-10</b>	Sheet of 40mm Targets	10	100m	40mm x 40mm
<b>03-RSZ6-4</b>	Sheet of 60mm Targets	4	120m	60mm x 60mm

**LASER SCANNER TARGETS**

**03-RSL301**

**LASER SCANNER TARGET**

- Suitable for use with scanners from Leica, Geomax and Faro
- Fixed points for connecting several positions
- Self-adhesive for quick and easy attachment
- Size: 200mm x 150mm (7.875" x 5.9")
- Waterproof, suitable for indoor & outdoor use



**03-RSL-X80 / 03-RSL-X90M**

**LASER SCANNER TARGET**

- Laser Scanner Targets excellently suited to scanners from Leica, Geomax, Faro, Z+F (Zoller+Fröhlich) and Trimble
- Fixed points for connecting several positions
- Allocation of spatial reference information to a geospatial dataset

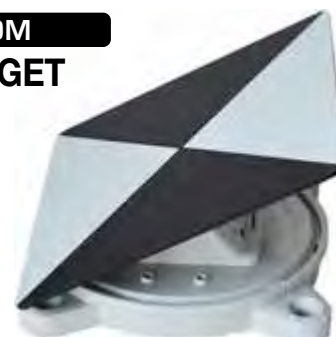

sku	Fixed Point
<b>03-RSL-X80</b>	Same XYZ coordinates when using the fixed point RSFP-X80
<b>03-RSL-X90M*</b>	Same XYZ coordinates when using the fixed point RSFP-X90M

\*Available through Special Order

**03-RSL402**

**ALU DIBOND LASER SCANNER AND DRONE SIGN**

- Laser scanner and drone sign, printed on both sides (grey-white / black-white), 400 x 400mm, for long range scanning
- When using mobile mapping systems, the plates can even be detected at speeds as high as 80 km/h
- Because of their size and shape, the plates can also be used for orienteering in systems for autonomous driving



**RSLT10**

**LASER TARGET, FOLDABLE FOR LINE LASER**

- Quickly set-up a line laser into an accurate position along the axis
- Can be used up to a distance of 30 meters even on sunny days
- Foldable and can be easily transported directly in the laser case



**ASK ABOUT OTHER ROTHBUCHER SYSTEM PRODUCTS**

\*Available through Special Order

**03-RSL500 SERIES**

**GROUND CONTROL TARGETS FOR DRONES**

- Targets, 350 x 350mm
- Survey points for use with drones
- Can be fixed to the ground with tent pegs
- Multifunctional
- Waterproofed
- Ideal for use up to a height of approx. 100 meters
- Marker visibility is device and weather-dependent

sku	use for
<b>03-RSL510*</b>	Ground Control Targets for Drones, single-side
<b>03-RSL512</b>	Ground Control Targets for Drones, double-sided
<b>03-RSL520</b>	Ground Control Targets for Drones, single-side
<b>03-RSL532</b>	Ground Control Targets for Drones, double-sided

*\*Available through Special Order*

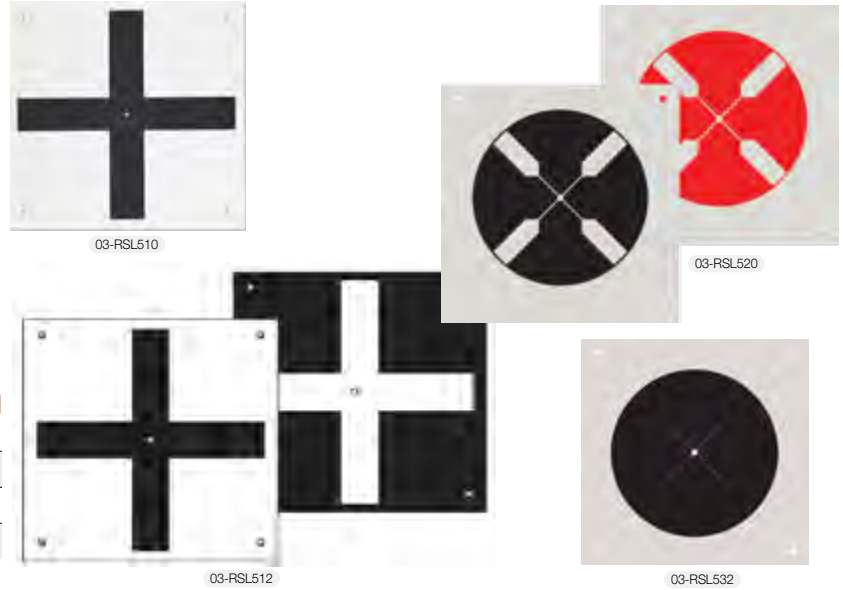

**03-RSL570 SERIES**

**GROUND CONTROL TARGETS WITH NUMBERS**

- Numbered Targets, 350 x 350mm
- Survey points for use with drones
- Can be fixed to the ground with tent pegs
- Multifunctional
- Waterproofed
- Ideal for use up to a height of approx. 100 meters
- Marker visibility is device and weather-dependent
- Each packaged in set of 10 targets

sku	use for
<b>03-RSL570-10</b>	Ground Control Targets for Drones, 1 - 10 numbers
<b>03-RSL570-20</b>	Ground Control Targets for Drones, 11 - 20 numbers
<b>03-RSL570-30*</b>	Ground Control Targets for Drones, 21 - 30 numbers

*\*Available through Special Order*



**03-RSFP1**

**MEASURING POINT**

- Aluminium plate with 5/8-11 stainless steel thread for screwing on a prism or instrument
- Fixed point at bottom, allows you to position instrument precisely above the cross
- When used as a fixed point on the floor, this point should be surveyed with a prism so that if necessary, e.g. suspected moving of the fixed point due to foul play, it can be checked quickly and easily
- Includes a plastic or aluminium protective cap for the 5/8-11 thread
- Size: 100mm x 100m





***Dave White's***  
**SitePro™**

**Dave White's SitePro**

Lafayette, IN

email: [info@dwsitepro.com](mailto:info@dwsitepro.com)  
website: [www.dwsitepro.com](http://www.dwsitepro.com)



© 2023 copyright Dave White's SitePro LLC. All rights reserved. SitePro and the Aperture & D W logo are trademarks of Dave White's SitePro LLC, in the United States and in other countries. Gammon Reel, GAMMAGNET, SITEGEAR, and Salamander are registered trademarks of Dave White's SitePro LLC. The David White brand and logo are exclusive trademarks to Dave White's SitePro. All other trademarks are the property of their respective owners. Due to the printing process, the colors of the products printed in this catalog may vary slightly from the actual product. Product images are not to scale. Design and specification of products are subject to change without notice.